

# collaboration

**4** Effective water recovery simplified through committed partnership

**10** Endress+Hauser releases Proline 300/500 smart flow instruments



## 4 Effective water recovery simplified through committed partnership



## 10 Endress+Hauser releases Proline 300/500 smart flow instruments



## 24 Cost-effective advances in radar level technology



- |  |   |  |
|--|---|--|
| <p>4 Effective water recovery simplified through committed partnership<br/>Dependable products and technical expertise for Clearas' ABNR system</p>              | <p>16 Process instrumentation calibration in the Life Sciences industries<br/>Simplifying the process with modern instrumentation</p> | <p>29 We learn from the customers we serve<br/>Committed to continually improve our support for our customers</p>                              |
| <p>8 Embedded resource provides customer satisfaction<br/>Professional Project services reduce risks and improves project timeline</p>                           | <p>19 E-direct online shop: purchasing simplified<br/>Saving you time and money</p>   | <p>30 Point level detection at the electrostatic precipitator<br/>Providing point level switching for low dielectric fly ash</p>               |
| <p>10 Endress+Hauser releases Proline 300/500 smart flow instruments<br/>Optimized for maximum safety, enhanced measurement quality and device accessibility</p> | <p>20 Basics of calibrating pressure transmitters<br/>Calibrating pressure transmitters for maximum performance</p>                   | <p>32 Contributions to SIS process measurement risk and cost reduction<br/>Advances in Endress+Hauser measurement and lifecycle management</p> |
| <p>12 Selecting radar level instruments for custody transfer<br/>FMCW or Time-of-Flight?</p>   | <p>24 Cost-effective advances in radar level technology</p>   | <p>34 Improve your brewery without breaking the bank</p>   |
|  | <p>26 How to slash energy costs with optimized aeration control</p>   |  |

## Registered Trademarks

W@M, HistoROM, Micropilot, Gammapilot, Solicap, Liquiline, Heartbeat Technology, Cerabar, Promass, Promag, Orbisint, Ecograph, Oxymax and Viomax are registered trademarks of Endress+Hauser. Bluetooth is a registered trademark owned by Bluetooth SIG. HART and WirelessHART are registered trademarks of the HART Communication Foundation. PROFIBUS and PROFINET are registered trademarks of PROFIBUS and PROFINET International (PI). FOUNDATION Fieldbus is a registered trademark of the Fieldbus FOUNDATION. Modbus is a registered trademark of Schneider Automation. EtherNet/IP is a registered trademark of ODVA, Inc. Tri-Clamp is a registered trademark of Ladish Co., Inc. All other trademarks are the property of their respective owners. All other copyrights are the properties of their respective owners.

# Embracing your future with Endress+Hauser



Dear Reader,

As we kick off 2017, we have taken the time to reflect back on where we have been, where we are going and where we ultimately want to be as your supplier in the process control and automation industry. We have evaluated our goals and values individually and as a family company. We realize in this ever changing, hypercompetitive business environment, growth is not optional, it is necessary.

As the market, trends and your needs and expectations grow and change, we must have solutions readily available for you before issues arise. We have placed focus on our customers and what we could do to better understand your issues and goals and we made them our priorities. We listened to your feedback and have developed and continue to develop solutions to ensure your key critical areas run continuously without interruptions.

With your concerns in mind, we proactively engage with youth starting in intermediate school, educating them on opportunities in advanced manufacturing. We partner with local colleges and universities to change curriculum and gear it more towards advanced manufacturing. We encourage those students who have recently graduated to enroll in our Rotational Engineering Program. During the program, our engineers receive a well-rounded education covering nearly every major area within our organization. After they have completed the program they become a resource we are able to place where you, our customers, see demand.

We are always evolving and developing our product lines to better meet your needs and demands. As we broaden our processes, services and solutions we are able to collaborate with and support you more than ever before by providing more innovative and economical ways to utilize our instrumentation. For example, our innovative and efficient Micropilot® FMR10/20 level transmitters with Bluetooth® capabilities and our new Proline Promass® Coriolis 300/500 flowmeters with Heartbeat Technology™ capabilities. You can learn more about our collaborations and innovations throughout the stories in the magazine.

As we continue to develop an understanding of your needs we are making certain our offering of services and solutions adapt to, meet and surpass your expectations. It is of the utmost importance we continue to build on growth, anticipate your needs and strive for excellence while gaining your trust in improving your processes and products sustainably and efficiently.

On behalf of the entire Leadership Team and all of us at Endress+Hauser, I would like to thank you for your business, continued support and allowing us the pleasure of being your trusted and dedicated automation supplier.

Sincerely,

A handwritten signature in black ink, appearing to read 'Todd Lucey', written in a cursive style.

Todd Lucey  
General Manager, Endress+Hauser, Inc., Sales Center U.S.





# CLEARAS

WATER RECOVERY

Clearas Water Recovery is a team of engineers, innovators and problem solvers. They design, build and operate next-generation ABNR solutions to deliver high quality wastewater treatment to its partner-clients at the lowest cost of ownership. Clearas ensures partner-clients success and support in engineering, biological processes and systems management.

Clearas Water Recovery  
Missoula, MT





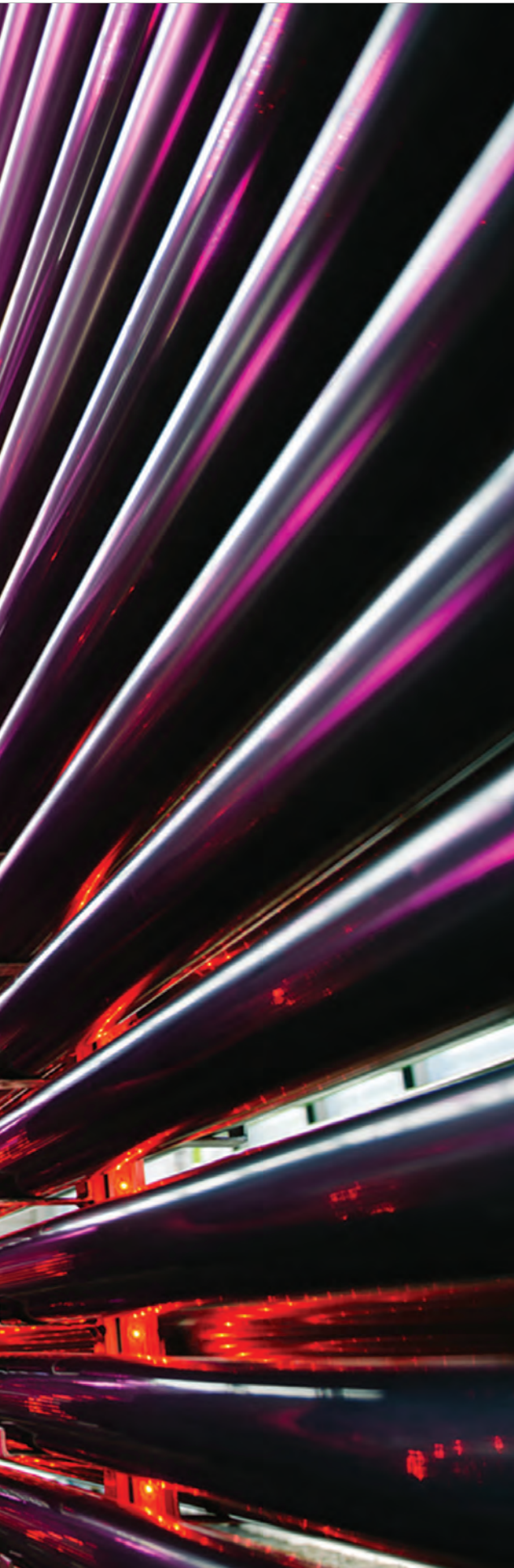

## Effective water recovery simplified through committed partnership

Endress+Hauser supplies dependable products and technical expertise for Clearas' ground-breaking ABNR system

Clearas Water Recovery was founded in 2008 with a vision and mission to develop wastewater treatment technology, which could recover nutrients in wastewater in a biological and sustainable way. The company's patented treatment platform, Advanced Biological Nutrient Recovery (ABNR) technology, is highly modular and scalable, providing a sustainable approach to cleaning water. The Clearas system consists of three core phases: the blend phase, the nutrients recovery phase and the separation phase. For optimal results, Clearas has partnered with Endress+Hauser for dependable products and reliable technical expertise.

**The challenge** With increased population and rapid industrialization humanity's most vital natural resource is threatened. Streams and waterways become contaminated with excess phosphorus and nitrogen which further decreases fresh water supply. Today, there is not enough clean usable water to satisfy demand.

The implementation of cutting edge wastewater treatment technology like Clearas' ABNR system requires extreme attention to detail and exacting control of process constituents throughout. From past experience, it was clear to Clearas that they needed best-in-class instrumentation with the quality and reliability necessary to maximize the success of client operations. Endress+Hauser products were a natural fit with the outstanding longevity, dependability, and value Clearas was looking for.

"With Endress+Hauser products we knew we would only have to buy them one time. We are so excited to have Endress+Hauser engaged. Now I do not need to worry about doing it all myself," says Kevin McGraw, Operations Manager & Co-Founder of Clearas.





#### The ABNR breakdown:

- **Blend:** Contaminated wastewater and carbon dioxide are mixed with a blend of algae and other biological organisms to create a biodiverse mixture flow.
- **Nutrient Recovery:** The mixture flow leaves the blend tank and enters the vertical pond system. This greenhouse structure and light source provide light year round for 24/7 nutrient recovery. The system optimizes biological activity and photosynthesis. Inside, the algae metabolize the unwanted contaminants and rapidly divide. The dense algae culture takes over and biologically cleans the water releasing oxygen.
- **Separation:** Advanced microfiltration separates the mixture flow into two different streams: the recycle stream and the clean water stream. The recycle stream returns the healthy algae and other biological organisms back to the blend tank to start the process over again. The excess waste and algae are harvested from the treatment process. The clean water stream is now free from harmful contaminants and is released back for reuse. This is where Endress+Hauser products play their vital role.

**Realization** Both the Chief Executive Officer, Jordan Lind, and McGraw realized a technological change was essential for their company and Endress+Hauser was it. They needed reliable, long lasting equipment. They replaced their existing unreliable products with Endress+Hauser's electromagnetic flowmeters and pressure transmitters. The automated controls regulate the relationship between the biology and the mechanical processes to maximize the ABNR system's treatment impact.

"We, as a company, are only as good as our supply chain," explained Lind. "We needed people to rely on, and Endress+Hauser is a world class company and has offered its technology, expertise and technical skills. Our performance as a company is dependent on the accuracy and timeliness of the data Endress+Hauser sensors give us."

#### Components:

- Promag® Electromagnetic Flowmeter
- Cerabar® M PMC51 Pressure Transmitter
- Liquiline® CM44x Transmitter: pH, Total Phosphorus, Dissolved Oxygen, TSS (total suspended solids), Conductivity

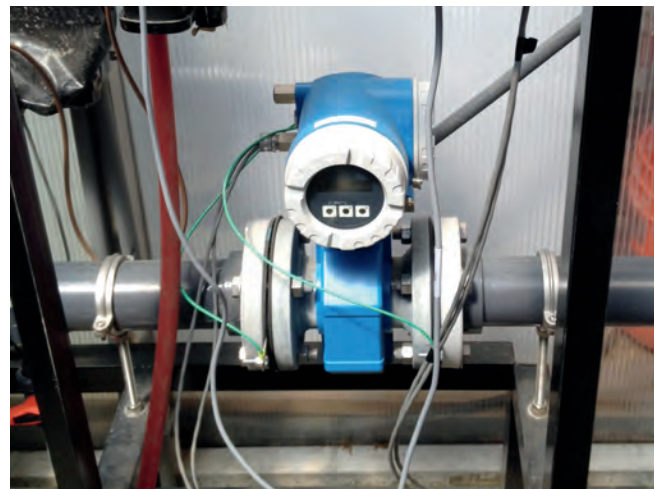



Jordan Lind,  
Chief Executive Officer

“Our performance as a company is dependent on the accuracy and timeliness of the data Endress+Hauser sensors give us.”



Kevin McGraw,  
Operations Manager &  
Co-Founder

“We are so excited to have Endress+Hauser engaged. Now I do not need to worry about doing it all myself.”

**Results:** “Endress+Hauser does what they say and says what they do. Our cultural core values align and these are critical for our relationship,” exclaimed Lind.

The benefits Clearas saw from working with Endress+Hauser technicians and products:

- Extremely accurate measurement
- Dependable quality
- Reliable and cost efficient
- Global presence
- Breadth of product offering
- Service support
- Ease of integration with system

#### The Clearas ABNR system benefits and results:

- Reduce phosphorus loads in post-secondary treated wastewater by an average of 93% in both municipal and industrial applications.
- Reduce nitrogen loads in post-secondary treated wastewater by an average of 33% in both municipal and industrial applications.
- Reduce phosphorus and nitrogen, increases dissolved oxygen, sequesters carbon dioxide, and positively impacts other constituents such as biological oxygen demand and total suspended solids.
- With a modular structure, the system can be scaled to fit any available footprint and has the flexibility to treat variable flow volumes. The Clearas system grows with you, scaling to comply with current permit requirements and accommodate future discharge requirements.
- Chemical treatment alternatives produce chemical sludge waste by-products with costly disposal fees. The system uses no chemicals, eliminates costly disposal fees, and produces only a natural biomass co-product for which markets are still being explored.
- The system is cost-competitive on a TCO basis with alternative technologies for ENR solutions, while achieving superior results and eliminating waste by-products.





# Embedded resource provides customer satisfaction

Endress+Hauser Professional Project services reduce risk and improves project timeline

## Benefits at a glance

- Reduce risk
- Meet and improve the project timeline
- Recommendations on best practices and eliminates oversights
- Drives consistency and quality
- Expert on-site, avoid long clarification cycle

A large global Engineering, Procurement and Construction (EPC) firm was working on a substantial petrochemical project. As with any project, the firm was challenged by their client to minimize risk, maintain the project timeline and stay on budget. Endress+Hauser was able to help them meet these goals by offering an on-site, embedded resource with extensive instrumentation experience.

## The Challenge

The firm, like most large EPCs, acquires complex projects that are colossal in scope - simply due to its size but also due to the many stakeholders who are invested in the project. These projects are becoming increasingly complex and demanding. Schedules and budgets are tight and safety is crucial.

For these types of projects, experience is needed in every part of the project. Endress+Hauser offered our expert know-how in instrumentation to minimize the risks associated with that portion of the project – we ensure those improvements!

## The Solution

In order to make sure the firm mitigates risks and increases efficiency, the client and firm agreed to have Endress+Hauser embed a resource into their engineering team. This subject matter expert delivers engineering expertise in the field of process instrumentation. Close collaboration with the firm's engineering disciplines,



including three different locations (Houston, Baton Rouge and India) helps to optimize all interfaces to process, control, electrical and piping.

“Having an Endress+Hauser representative in-house is an added value and creates a seamless experience,” said Shannon M., the firm's Senior Control System Engineer. “If a client has an issue or I have a question on dimensions, they are right there to assist.”

## Solution Details

An Endress+Hauser subject matter expert is embedded into your engineering team working to help reduce risk with immediate on-site support. The expert of the products, solutions and services provides the knowledge and expertise on process automation field devices. The





embedded resource resolves issues immediately keeping the project on time and on budget. Having this resource also reduces repetitious external communications and the inherent delay caused by emails and phone calls, keeping your resources productive. The manpower is supplied to the project as needed and also reduces risk of increased direct costs.

### Results

“Howard Siew [our Endress+Hauser embedded resource] embodies what a representative should look like: he has the knowledge, skillset, professionalism and customer service down to a T and you can’t teach that,” exclaimed Shannon M. “I can’t give him a good review because I need to give him an exemplary review! He goes above and beyond; any

company would be honored to have Howard represent them.”

“We have an embedded Endress+Hauser engineer that works along with our project team. This has helped save time by getting quotes, dimensional data and questions answered in a shorter amount of time. With the right person, this could be beneficial in other projects,” said Warren W., the firm’s Project Engineer.

Since having an Endress+Hauser embedded resource on the project, the EPC firm has been able to provide fast, dependable and reliable services and solutions to their client. Let Endress+Hauser provide the experience needed to help your project team reduce risk and improve your project timelines.

# Endress+Hauser releases Proline 300/500 smart flow instruments

The Coriolis and electromagnetic flow instruments have been optimized for maximum safety, enhanced measurement quality and device accessibility.





Endress+Hauser's Proline 300/500, is a family of industry optimized "smart" Coriolis mass and electromagnetic flow instruments that simplify installation, speed commissioning, and streamline both operation and maintenance activities.

The Proline Promass Coriolis mass flowmeters are available in 11 models ranging in sizes from 1/4 to 14 inches in diameter, for measuring flows up to 100,000 tons per day. Proline Promag flowmeters are available in three models in sizes from 1/2 to 78 inches for volume flows up to 634 million gallons per day. Both types are available in models suitable for high temperatures, corrosive fluids, hygienic and sterile process applications.

Proline instruments connect to control systems via 4-20mA HART®, PROFIBUS® PA, FOUNDATION™ Fieldbus, Modbus®, EtherNet/IP™ or PROFINET®. Both families provide access to users via the device's display, a web server, a wireless LAN, handheld devices, asset management or process automation solutions, and Fieldbus protocol. Each provides fast commissioning, in-situ device verification during operation, continuous self-diagnostics and automatic on-board data storage.

Both families have robust transmitter housings available in aluminum, hygienic or severe service stainless steel. Each housing has a two-chamber system with a front-mounted compartment for connecting source power, wiring the analog and/or digital inputs and outputs, and accessing the Ethernet service access port or device display. The second chamber permits service technicians to access the electronics modules for repair functions while maintaining protection against dust and contamination.

Local or remote four-line backlit optical displays with a WLAN connection allow access from a handheld device such as a smartphone or a tablet.

All Proline instruments have custody transfer approvals and meet the requirements of cCSAus, ATEX, NEPSI, INMETRO, EAC, IEC/EN 61326, NAMUR NE21, and EU and ACMA directives. They are also approved for use in SIL 2 and SIL 3 applications.

## Smart instrument functions

Each Proline instrument has a HistoROM® function to protect data storage automatically. This includes an event logbook and data logger that can be accessed locally or remotely, and storage of calibration and verification information. This onboard data storage makes it easy to replace and commission a new flow sensor.

The built-in web server provides universal browser-based access to device, diagnostics and process information from any device with an internet or Wi-Fi connection. Typical access devices include laptops, PCs, smartphones and tablets.

## Heartbeat Technology

Endress+Hauser's Heartbeat Technology™ package addresses device diagnostics, monitoring and verification functions used to satisfy regulatory, contractual, quality, safety or fiscal requirements.

Heartbeat Diagnostics provides self-monitoring for all Proline instruments meeting NAMUR NE107 requirements for clear and unambiguous categorization of events and device remedies for quick resolution of problems.

Optional Heartbeat monitoring allows for customer identification of device trends from process influences such as buildup, settling solids or liquids, erosion, corrosion and multi-phase fluid flows.

The TÜV-attested Heartbeat Verification is the only method to have achieved third-party accreditation per traceable ISO metrological standards in operation. In-situ verification can be triggered at any time, from anywhere, to provide electronic quality reports.

## Lifecycle management

The Proline instrument portfolio also connects directly to Endress+Hauser's W@M® lifecycle management software which tracks all necessary information about device calibrations, verifications, maintenance, and other functions over the life of the sensor and instrument.



For more detailed information on the Proline flowmeters, please visit:  
[www.us.endress.com/proline-300-500](http://www.us.endress.com/proline-300-500)

# Selecting radar level instruments for custody transfer

Which radar level technology is best for tank gauging in custody transfer applications, FMCW or Time-of-Flight?

By Brian Howsare, Endress+Hauser



**FIGURE 1.** Radar level instruments have the necessary accuracy for custody transfer applications.

Measuring the level of tanks used to hold fluids for custody transfer can be expensive. This is not due to the cost of the measurement instrumentation, but to what inaccurate measurements can cost the company.

For example, consider a company with 10 oil tanks each filled and drained once a week. If the level instruments have  $\pm 3$  mm accuracy per the company's technical specifications, and each tank holds two million gallons, the uncertainty in the measurement is about 554 gallons per week. At \$45 per barrel, that represents an error of \$600. In one

year of operation, that's \$31,200. Multiply that out to 10 tanks, the error could potentially represent \$312,000 per year in unnecessary losses due to less accurate inventory measurement.

Compare that loss to level instruments with 0.5 mm accuracy. The possible error is only 93.25 gallons per week, for a total cost of \$52,000 per year for 10 tanks. Installing better level instruments could save the company \$260,000 per year in reporting unnecessary losses due to more accurate inventory measurement.

In many applications, higher-accuracy measurements are required to protect the customer from over-billing and the supplier from under-billing. Common products requiring this level of accuracy are typically oils, fuels, edible oils and alcohols. In the Oil & Gas industry, this requires a system called automatic tank gauging (ATG) as defined by the American Petroleum Institute (API) standards.

For this same reason, groups around the globe either make recommendations or dictate the equipment accuracies needed when using level-based (static) inventory accounting for custody transfer,



trading products or tax payment evaluation. Some of these groups, standards and guidelines are NMI, PTB, OIML R85 and API 3.1B. In general, these groups require a radar level instrument with better than 1 mm level accuracy.



**FIGURE 2.** FMCW radar sends a continuous wave that reflects off the surface and returns to the antenna. The shift in frequency determines the level in the tank.

Frequency modulated continuous waveform (FMCW) and pulsed Time-of-Flight (ToF or PToF) are the two technologies used in modern radar-based tank gauging instruments, and there is often confusion about which is best. In reality, they both perform to the specifications for custody transfer determined by the above groups. Both technologies have been around for more than 20 years and are proven in many applications, so the short answer is: Both technologies meet the stringent requirements for <1 mm high-accuracy level measurement.

This article provides an overview of the differences between FMCW and ToF radar used for custody transfer.

## Calculating level

FMCW radar (Figure 2) transmits continuously, with the radar signal reflecting off the liquid surface received by the radar antenna. The shift in the frequency of the return signal is then used to calculate distance to the liquid.

The calculations are:

1.  $\Delta f \approx \Delta t$

Where running time  $t$  is a function of the change in frequency  $f$

2.  $d = t * c / 2$

Where:

$d$  = distance between instrument sensor and surface  
 $t$  = running time  
 $c$  = speed of light

ToF radar (Figure 3) transmits energy in the form of a pulse which reflects off the liquid surface and is received by the antenna. The time it takes for this to happen is then used to calculate the distance to the liquid.

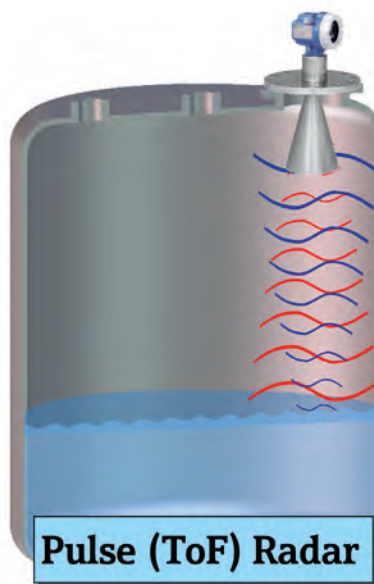

**FIGURE 3.** Pulse radar sends radar pulses that reflect off the liquid surface. The Time-of-Flight (ToF) determines the level of the liquid.

The level calculation is much simpler than FMCW as it is based on actual time:

$$d = t * c / 2$$

Where:

$d$  = distance between instrument sensor and surface  
 $t$  = running time  
 $c$  = speed of light

## Refuting sales pitches

One of the problems in selecting the proper radar level instrument is dealing with sales pitches from suppliers. A supplier selling one type of radar instrument but not the other might make various questionable claims which might have been true in the past, but are not any longer. Some of these sales pitches were:

- FMCW requires more power to operate than ToF, and needs a four-wire connection. This is no longer true. FMCW can be powered by a two-wire 4-20mA connection.
- FMCW is more expensive than ToF. No longer true. Pricing is now about the same.
- FMCW is more accurate than ToF. Both technologies meet the API Custody Transfer accuracy.
- FMCW has temperature stability problems. No longer true. In the past, FMCW radars used analog components requiring a stable temperature to produce a linear output. Today, digital components have solved the problem.

Essentially, there are no significant differences between the two technologies except for the algorithm used to calculate level. Selecting a radar level instrument, then, is more about the beam angle and the intended application.

Antenna Size	6 GHz	10 GHz	26 GHz	80 GHz
2"	---		18°	4°
3"	---		10°	3.5°
4"	---	21°	8°	3°
6"	23°	15°	5°	---
8"	19°	10°	4.4°	---
10"	15°	8°	3.3°	---
18"(17")	7°	(6°)	---	---

FIGURE 4. Beam angles vary according to the frequency of the radar signal and the antenna size.

### Frequency vs. beam angle

As shown in Figure 4, the beam angle—the amount of spread in the radar signal—is dependent upon the size of the antenna and the frequency of the radar signal. For example, the largest spread of 23 degrees is produced by a low-frequency 6 GHz radar and a 6-inch antenna. The smallest spread of only 3 degrees is produced by a high-frequency 80 GHz radar with a 4-inch antenna.

Beam angle is important because it determines how close the radar instrument can be installed to the tank wall (Figure 5). The beam should never reach the tank wall because it will interfere with the radar signal. For example, when a radar instrument with a large beam angle is installed too close to the side wall, this causes non-linear inaccuracies throughout the measurement range.

A narrow beam angle lets the instrument be installed close to the tank wall and makes it easier to find a location where it will not get a reflection off obstacles in the tank such as heating coils, fill/drain pipes or mixers.

But a wide beam angle has its advantages. For example, a 6 GHz radar instrument has a lower, broader frequency than an 80 GHz instrument, so it's better at penetrating steam and vapor. Wide beam angles are also beneficial in tanks with waves or agitation, as it provides more of an

average representation of the liquid surface, and a 6 GHz frequency is better when radar is used in stilling wells. For custody transfer storage tanks, the surface is calm so factors like steam, agitation, waves, etc. are not a factor.

Antenna size is important because it determines the size of the opening needed in the top of the tank. A drip-off lens antenna is preferred because condensed water or oil will drip off the antenna and not coat it.

Ideally, a radar instrument should be installed as close to the tank wall as possible, given the limitations imposed by the beam angle and the size of the hole needed to mount it. Mounting it close to the tank wall minimizes the

need for maintenance technicians to walk on the top of the tank when servicing the instrument, thus reducing safety hazards.

Also, the farther away from the sidewall of the tank, the less stable the radar's gauge reference height (GRH) will be. Rain, ice, snow, temperature changes or someone walking on the roof to gauge the tank can easily cause several mm of deflection, which in turn changes the GRH of the instrument. Mounting the instrument close to the tank wall allows installation on the most rigid part of the roof, where the instrument is less affected by tank distortions.

For floating tank roofs, one solution is to mount the radar sensor inside a stilling well that's not affected by the roof moving up and down. Some companies mount a lower accuracy radar 5-10 ft out from the side to measure a reflection off the roof itself, but that brings inaccuracies due to the roof tilting or water/snow accumulating and changing the buoyancy.

When selecting a radar level instrument, variables such as vessel height, the presence of obstructions, mounting distance from the side wall, available nozzle sizes, and other considerations may require testing by an instrument supplier and the end user to determine which solution is best for each application.

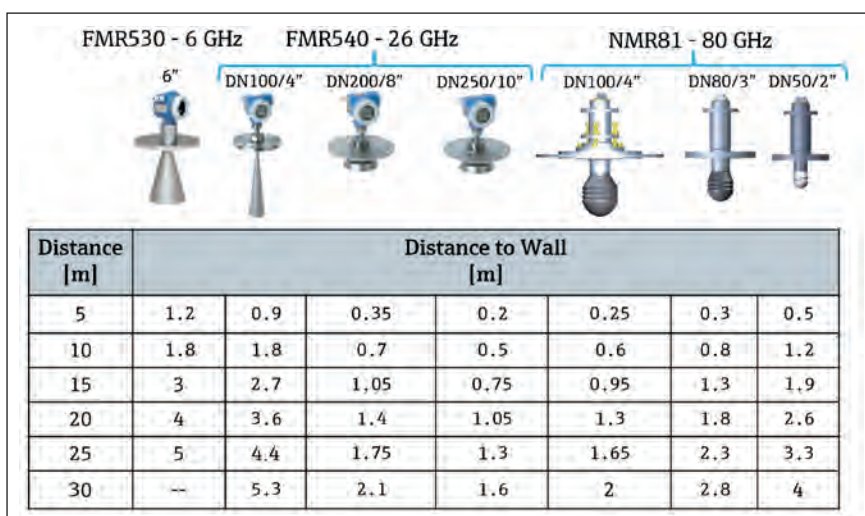
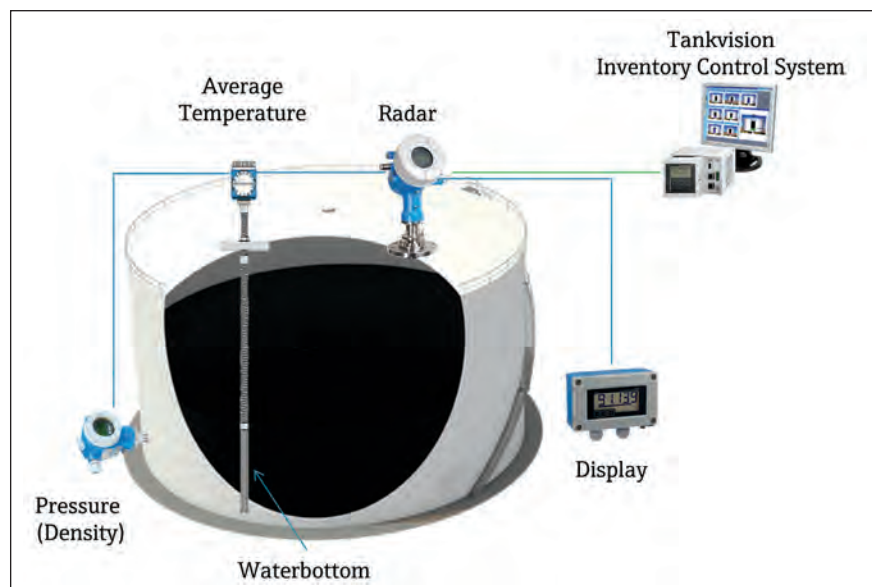

FIGURE 5. Distance the radar sensor can be mounted from the wall depends on the beam spread and height of the tank. For example, in a 15m (50 ft) tall tank, an 80 GHz sensor with a 4 in. antenna can be mounted 0.95 m (3.11 ft) from the tank wall.





**FIGURE 6.** The waterbottom in a tank affects the level measurement of the oil floating above it. A complete tank gauging system needs level, temperature, waterbottom and pressure (when measuring mass) instruments, as well as inventory control software to process the data.

The most significant development in ATG applications is the 80 GHz FMCW radar level instrument. Its narrow beam angle of three degrees is the smallest available, allowing it to be mounted closer to the tank wall than lower-frequency models. The antenna size of a 80 GHz instrument is two to four inches in diameter, so it can be mounted in existing and smaller diameter nozzles, such as those used for older level instruments or locations where a company performs manual hand gauging.

FMCW technology has been around for many years, but it was cost-prohibitive in some applications until component and material costs came down. This is why 6 GHz or 26 GHz pulsed ToF radar was mostly used for level measurement. But converting from analog to digital components not only brought down the cost of FMCW instruments, it also allowed suppliers to add more capability to the instruments.

For example, Endress+Hauser's 80 GHz device performs predictive measurements with its on-board microprocessor and alerts operators when problems arise. Diagnostic software checks electronics temperature, voltage inputs, near-field/by-horn measurements, and relative echo amplitude to determine the strength of a returning signal.

These algorithms and diagnostics can be used to predict process upsets before they occur.

### Beyond the level

Most installations will include either a spot temperature or - for better inventory accountability - an average temperature based on up to 16 RTDs that measure temperature at various levels in the tank. The temperature is used to do volume correction based on the API tables.

Some applications require compensation for changes in density, when making a mass measurement. For these applications, a pressure instrument is included to provide the average mass measurement of the vessel contents.

In many vessels it is also necessary to measure water accumulated in the bottom of the vessel, called waterbottom (Figure 6). Most of the accumulation comes from water that drops out of petroleum- and oil-based liquids, but water can also come from vents in the vessel and gaskets on floating roof tanks. The water separates and sinks to the bottom of the vessel and must be accounted for to calculate the net standard volume (NSV) of product in a vessel.

One obvious reason for measuring the waterbottom is so only the desired product is measured and paid for in custody transfers, not the water. The measurement allows deduction of water from the NSV as part of the tank gauging system. Removing water is also done for maintenance reasons to prevent rust on the tank floor, which can lead to leaks and resulting environmental hazards. Waterbottoms are typically measured using a capacitance level instrument that can detect the interface between water and oil.

Calculating level, mass and volume from oil level, waterbottom level, pressure and temperature instruments in accordance with various regulations is usually accomplished by specialized tank inventory management software, which provides the corrected volume and/or mass using embedded API Tables.

### Summary

Custody transfer and other critical tank gauging applications require a level instrument with extremely high accuracy. Both ToF and FMCW radar instruments provide the necessary accuracy to meet all regulations in the oil industry. The recent availability of 80 GHz FMCW radar level instruments makes it possible to install level instruments closer to the tank wall for improved operations and stability, and also provides other benefits.

# Process instrumentation calibration in the Life Sciences industries

Life Sciences companies must perform regular calibrations of instrumentation to meet regulations, but these can be costly. Modern instrumentation simplifies the process.

By Ravi Shankar, Endress+Hauser

To fulfill regulatory compliance and ensure quality, Life Sciences companies must perform traceable calibrations on instruments. But calibrations are costly, time-consuming, can cause process downtime and pose an increased risk for contamination.

Many instruments on the market today provide self-diagnostics features which give users information about the health of the device. In this article, we'll discuss how modern instrumentation simplifies the calibration and verification process.

## Calibration vs. Verification

Legal requirements for regular checks are commonly fulfilled with wet calibrations. A calibration of an instrument - for example a flowmeter - involves determining and documenting the difference between the value read by the instrument and a reference value.

Traceability is accomplished by a formal comparison to a reference standard which is directly or indirectly related to national or international standards. Detected deviations between the displayed value and the reference value can be corrected after the calibration by adjusting the calibration factor. A calibration protocol is issued to document the findings.

The downside of wet calibrations is that the instruments typically have to be removed from the process and connected to a calibration rig or a



master meter. After the calibration, the instrument is then sent back to the facility to be installed again. Damages during transport or handling can sometimes stay undetected and can lead to a situation where a recently calibrated instrument is not performing according to specifications.

Alternatively, a mobile calibration unit can be used to perform a calibration on-site. This method typically eliminates the need for dismantling the meter under test, but still requires the primary process loop be opened, increasing contamination risk.

An alternative way to fulfill legal requirements is in-situ verification of the device. Here, the device runs an on-board diagnostics program where all relevant components of the instrument

are checked to confirm and document the instrument still meets factory conditions and that no parts have been altered or changed, or have drifted (Figure 2).

Several instrument makers offer in-situ calibration and verification, and all work in a similar fashion. The system in Figure 2 is based on Endress+Hauser's Heartbeat Technology™, which provides documented proof that a flowmeter performs according to specification.

If a device is equipped with Heartbeat Technology, all test sections are monitored continuously and are part of the standard device diagnostics (sensor, front end, reference, I/O loop). If a verification is initiated, the current status of all diagnostics parameters are read and stored with a unique



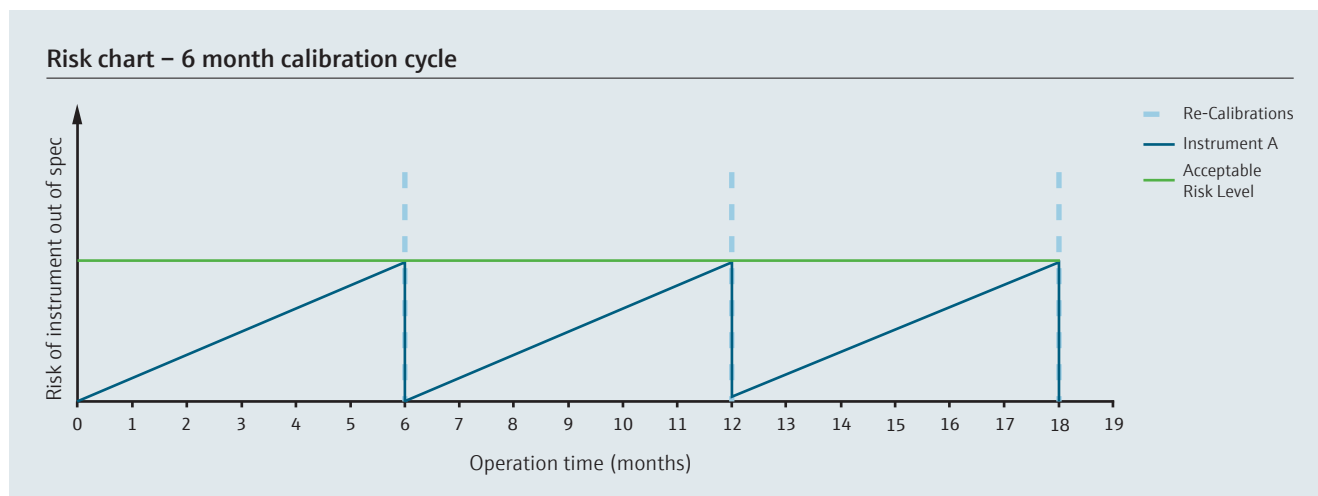

FIGURE 1. Six-month calibration cycle based on manufacturer’s recommendation.

identifier in the failsafe memory of the flowmeter. A verification report in PDF format is generated based on the diagnostic data of this snapshot. This report can be downloaded, printed or stored externally for audit documentation.

The purpose of instrument verification is to provide a tamperproof verification document confirming the status of the device, similar to a calibration certificate. These qualitative verification results have the same value as a wet calibration and can be used in an equal manner to prove the device under test is still fit for the defined operation.

The main advantage of an embedded verification is that the instrument does not have to be removed from the process, and therefore the risks of damage due to the handling and cross contamination of the process loop are eliminated. Process interruption is also not usually required as the verification tests can all be performed in the background while the instrument is still performing its intended function.

### Requirements for on-board verification

Calibrations and verifications have to be traceable to national or international standards to fulfill regulatory requirements. Wet calibrations achieve traceability by using calibration rigs or master meters accredited according to ISO 17025. A more complex situation presents itself for devices with built-in self-verification functionality. Integrated solutions have to rely on a network of redundant components and built-in traceable references.

The entire signal chain of the instrument has to be analyzed for possible errors and their subsequent impact on the system and its measuring accuracy. Typically a Failure Modes Effects and Diagnostic Analysis is used during the device design phase to identify critical components in the signal chain. This analysis starts at the process wetted parts, followed by the electro-mechanical components, the amplifier board, the main electronics and the outputs. As a result, a proper safety measure has to be assigned to every critical path or component.

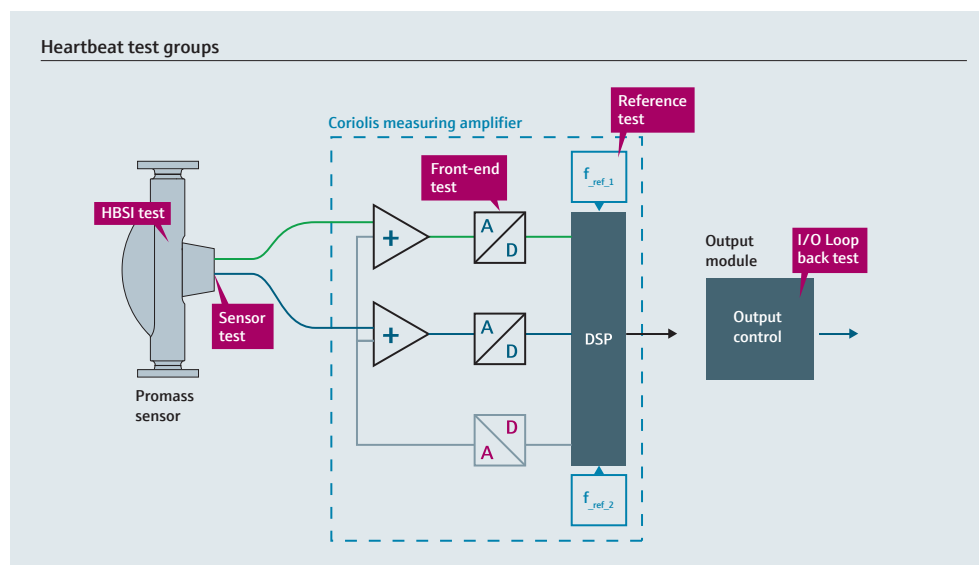

FIGURE 2. This diagram illustrates the test groups for an Endress+Hauser Proline Promass Coriolis mass flowmeter. The entire signal chain from sensor to output module is included in the flowmeter verification.

Measures include digital signal processing and continuous loop checks with the help of internal reference components. For an internal component to be used as a diagnostic reference it has to fulfill special requirements such as factory traceability and exceptional long-term stability.

For the most critical circuits, independent and redundant components are implemented to reduce the possibility of an undetected drift. Using modern technology, it is possible to design instruments with a self-diagnostics coverage of 94% or higher (in accordance with IEC 61508), and low expected rate of undetected failures.

### Verification on the go

The benefit of built-in verification is that it can be easily initiated locally or remotely from the control system, usually with no process interruption. A meter can be verified on a daily basis, drastically reducing the unknown period between calibrations. In batch applications, a system check can be initiated from the control system prior to starting the batch to ensure all devices work properly. Such a system check greatly reduces the risk for unplanned shutdowns due to instrument failures.

Built-in verification can also save a significant amount of maintenance time and reduce the need for unnecessary calibrations. Figure 3 shows two instruments (A and B). Instrument A (blue) has to be recalibrated every six months based on the manufacturer's recommendation. Instrument B (orange) is equipped with an embedded diagnostics and verification system and is verified bi-monthly by the means of an automated diagnostics system. Due to the higher test coverage of the diagnostics system, Instrument B requires wet calibration only once every 2.5 years. Instrument B is generating 80% savings on maintenance cost while at the same time achieving a significantly higher confidence level than instrument A.

### Summary

Wet calibrations are still the most often used method to check an instrument and demonstrate regulatory compliance. State-of-the-art instruments with embedded verification capabilities offer the chance to improve upon this practice. Performing regular verification on the instrument can extend calibration cycles by a factor of five or higher without jeopardizing quality or regulatory compliance. Shorter unknown periods between checks lead to an increased confidence level and reduced risk for critical applications.

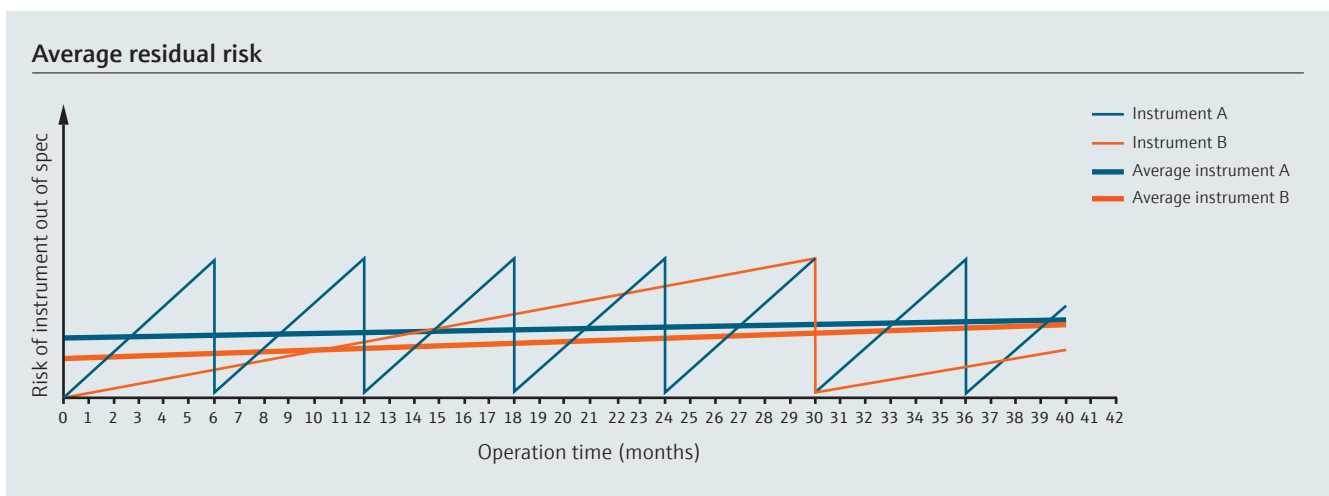

FIGURE 3. Calibration vs. verification.





## E-direct online shop: purchasing simplified

The home of high quality switches, sensors, components, displays and recorders has been improved to save you time and money when shopping for devices fit for fundamental applications.

In October 2016, Endress+Hauser introduced the new and improved E-direct online shop, adding a host of new functionalities and a larger selection of products.

What can you expect from the new and improved E-direct shop?

- **High quality – low cost:** The durability and reliability you've come to expect from Endress+Hauser products along with improved pricing and volume discounts.
- **Improved delivery times:** All products will now show expected shipping times at checkout, with some of our most popular products now shipping within 48 hours.
- **Easier navigation, selection and checkout:** The convenient navigation, enhanced search functions and filters, more detailed technical information, and 360° product photos will help streamline your shopping experience.

 Curious about the new shop?  
 Check it out at [www.e-direct.us!](http://www.e-direct.us!)





# Basics of calibrating pressure transmitters

Pressure transmitters need to be calibrated on a regular basis for maximum performance. When do you do it? How do you do it? And who does it?

By Keith Riley, Ehren Kiker and Duane Muir, Endress+Hauser

Pressure transmitters used in the process industries are very durable and reliable instruments. Even so, they still require periodic maintenance and calibration to ensure optimal performance. This is an area of confusion for many, with these and other questions:

- Are we calibrating our transmitters too often, resulting in excessive downtime and unnecessary maintenance expense?
- Are we calibrating our transmitters too infrequently, resulting in quality issues and possible loss of product?
- Are we calibrating our transmitters correctly?

As with most things in life, there is no “one size fits all” answer. However, there are simple best-practice guidelines, which can be modified to fit specific applications. This article helps answer the basic questions facing process plant personnel with regard to calibration.

## How often?

Each process plant has to determine correct calibration intervals based upon historical performance and process-related requirements. Factors you need to consider that may influence this decision are:

- Are there any local, national, safety or environmental regulations that must be observed?
- What is your reason for requiring calibration: quality, safety or standard maintenance?

### Process conditions:

- Is there a homogeneous process fluid with a stable pressure/temperature?
- Will the process conditions fluctuate significantly?
- Is there risk of buildup, corrosion or abrasion to the pressure transmitter?
- Will heavy vibration be present?

### Ambient conditions:

- Will the pressure transmitter be installed in a well-controlled environment with low humidity, normal/stable temperatures, and few contaminants such as dust or dirt?
- Is an outdoor transmitter exposed to widely varying weather conditions or high humidity?



If you have no significant history or regulatory requirements to guide you in developing your calibration procedures, a good place to start is with the following general guidelines:

- Direct mounted pressure transmitters installed inside in a controlled environment on a process with stable conditions should be calibrated every four to six years.
- Direct mounted pressure transmitters installed outside on a process with stable conditions should be calibrated every one to four years, depending upon ambient conditions.

If a remote diaphragm seal is employed on a pressure transmitter, the calibration interval should be reduced by a factor of two; i.e., a four to six year interval is reduced to two to three years. This is because a remote diaphragm seal will employ more fill fluid than a direct mounted configuration. Consequently it will experience more mechanical stress from process or ambient temperature fluctuations. Most remote diaphragms are flush faced where the diaphragm/membrane is susceptible to physical damage (dents or abrasions) that can cause offset or linearity issues.

If the process regularly experiences significant pressure swings or over pressurization events, reducing the calibration interval by a factor of two is a good rule of thumb.

### How accurate?

How good is good enough? In other words, what is the Maximum Permissible Error (MPE) for your calibration?

Many make the mistake of adopting the manufacturer's reference accuracy as their calibration target. Unfortunately, this means they will have a MPE that is too tight, with a high rate of non-conformance in their calibration process. In the worst case with a very tight tolerance MPE, it may not be possible for their field or lab test equipment to calibrate some of their transmitters.

A manufacturer's reference accuracy is based upon tightly controlled environmental conditions seldom if ever duplicated in a plant environment. Using that reference accuracy for a calibration target also fails to take into account the long term stability of the instrument.

Over time, all instruments will experience slight accuracy degradation due to aging and simple wear and tear on mechanical components. This needs to be considered when establishing the MPE. In general, unless there are mitigating circumstances, it is better to set a reasonable MPE achievable with standard field and lab test equipment.

Test equipment starts with an accurate pressure source to simulate the transmitter input. The corresponding output is measured with a multimeter for a 4-20mA transmitter, or

with a specialized device for smart transmitters with digital outputs such as HART, FOUNDATION Fieldbus, PROFIBUS or EtherNet/IP.

The test equipment you intend to use should be traceable to the National Institute of Standards and Technology. As a general recommendation, your reference equipment should be at least three times more accurate than the pressure transmitter being calibrated.

### Performing the calibration

Once your calibration interval and MPE have been established, you are ready to perform the actual calibration procedure on your pressure transmitter. The best practice recommendation from Endress+Hauser is:

1. Mount the transmitter in a stable fixture free from vibration or movement.
2. Exercise the sensor/membrane before performing the calibration. This means applying pressure and raising the level to approximately 90% of the maximum range. For a 150 psi cell that would mean pressurizing it to 130-135 psig. Hold this pressure for 30 seconds then vent. Your overall results will be much better than if you calibrate "cold."
3. Perform a Position Zero Adjustment (zero the transmitter). This is important because the fixture used for calibration may be different than how the transmitter is mounted in the process. Failing to correct for this by skipping this step can result in non-conformance.
4. Begin the calibration procedure. Typically this means three points up (0% / 50% / 100%) and then three points down. The 4-20mA output should be 4mA, 12mA and 20mA at the three points (or the correct digital values for a smart transmitter). Each test point should be held and allowed to stabilize before proceeding to the next. Normally that should take no more than 30 seconds. More points can be used if you require a higher confidence in the performance of the instrument.
5. Compare the results of your pressure transmitter to your reference device.
6. Document the results for your records.

The calibration should be performed in as stable an environment as possible because temperature and humidity can influence the pressure transmitter being tested as well as the pressure reference.

If the results of your calibration are within the MPE, do not attempt to improve the performance of the transmitter.

One mistake many end users make is to regularly perform a sensor trim adjustment of their pressure transmitter—even on new units from the manufacturer. A sensor trim corrects the digital reading from the sensor after the A/D

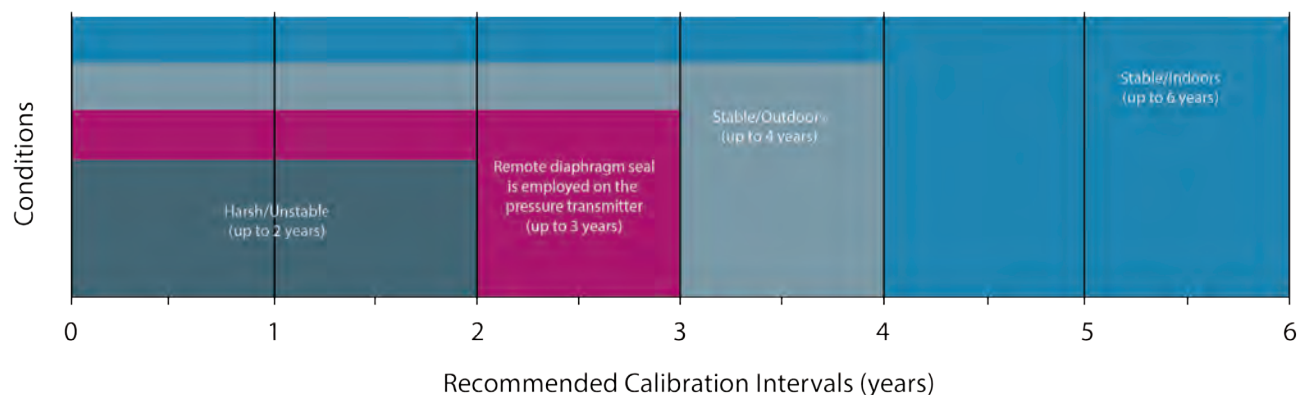

conversion. Performing a sensor trim on a new transmitter is essentially a single point calibration under current plant environment conditions, as opposed to sticking with the original factory calibration.

Factory calibrations of pressure transmitters are performed in a tightly controlled environment and incorporate up to as many as 100 test points. Performing a sensor trim on a new pressure transmitter under field conditions will result in a unit that operates at less than optimal capacity. A sensor trim should only be performed by a qualified technician under the manufacturer's guidance.

### Who should perform the calibrations?

Even with the sophisticated calibration and reference equipment currently available, there is no substitute for a properly trained technician when it comes to calibrating pressure transmitters. Not only does the technician need to be trained on the mechanics of the calibration process, he or she also needs to be equally qualified in completing and maintaining the documentation. Repeatability is the key and in the world of calibration, if it isn't properly documented, it didn't happen.

Occasionally there are some calibrations that cannot be performed in a standard maintenance shop by maintenance technicians. For these cases, an ISO 17025 accredited organization is required. Not only can an ISO 17025 accredited organization perform more stringent calibrations, they provide other value as well:

- Accredited labs can simplify the calibration audit process.
- The process and methodology used by an accredited lab is extremely repeatable, thus producing a high level of confidence in the results from an auditor's perspective.
- Annual audits of the accredited lab ensure they are consistently performing at a high level for their registered scope of work.

### Summary

The "correct" calibration cycle for a pressure transmitter will depend on the purpose of the calibration and the application. The same pressure transmitters employed in different operating units or processes at the same plant may require different calibration intervals.

Even more important than the calibration interval of the instrument are:

- Establishing correct and realistic MPES
- Following correct calibration procedures
- The training of the person performing the calibration
- Proper documentation of calibration results

Following these guidelines and using judgment based on actual plant operation conditions will help establish proper calibration practices, saving money while maintaining acceptable performance.





# Cost-effective advances in radar level technology

You can't control what you can't measure. It seems simple enough, but accurate measurement can be one of the more complicated aspects of operating a water, wastewater, or industrial plant. There are unexpected hiccups in the process that can alter recordings, hazardous conditions to contend with, and tons of data to collect and analyze.

To find out how to make the most out of measurement, we turned to Endress+Hauser's Dean Mallon, the National Level Product Manager. He talked to us about the challenges of measuring liquids in water and wastewater operations, how operators can leverage the precision of radar, and utilizing data to make everything easier.

## What are some of the challenges most people might not consider when it comes to measuring liquids in water and wastewater treatment?

Many people do not keep in mind that disturbances can happen during a process — things like an unanticipated increase in foam or sludge, which put reliability and accuracy at risk and could lead to the loss of the signal.

## How has liquid measurement evolved over time in the water and wastewater industries?

As the cost of goods has lowered and manufacturing practices have become more efficient, there has been a decrease in the cost of purchasing manufacturing instruments. This means higher-quality, more accurate technology becoming affordable to more customers.



## How does radar measurement work?

Radar is a Time-of-Flight type of measurement. It is a calculation of the distance between the device and the product surface. It utilizes the formula “ $D = C \times (T/2)$ .” In that formula, D represents distance; C represents the

dielectric constant, with air being one and water being 80; and T represents the time it takes for the measurement to be emitted, reflect off the liquid, and then travel back to the device.

### How innovative is radar measurement?

Radar measurement has been around for a number of years, and there are innovations still happening within this technology. The algorithms that take the information collected by the radar unit are what continue to evolve, and that's really the innovative piece



that differentiates one manufacturer from another. The goal is to increase reliability and safety while making the transmitter easier to configure and set up.

### Why has the ability to access measurement data become popular for water and wastewater treatment operators?

The ease of use and quick access of measurement data aids in their evaluations when challenges occur. It also helps to demonstrate quick return on investment of the equipment. The more data an operator has on their process, the easier it becomes to run the plant in a more efficient manner by reducing operational costs.

### How does Endress+Hauser's Micropilot FMR10 and FMR20 take advantage of the latest capabilities for remote data access?

We use Bluetooth® technology, so operators can easily access all of the data for evaluation, order spare parts, and confirm the instrument in question is running as expected. We also use our HART [Highway Addressable Remote Transducer] communication in the device, so data can be accessed locally or at any point along the power loop.

### Can this data still be collected and accessed in hazardous conditions?

Yes, through an appropriately rated Bluetooth-enabled smart device and through HART if the communication device is rated appropriately.

### How can operators leverage the data provided by Micropilot to improve operations?

With our FMR10 and FMR20, the envelope curve from both Bluetooth and HART is key to actually seeing what is happening with the process and managing a quick reaction time with accurate information. Quick, accurate information increases the runtime, quality and efficiency of the process.

Across our Micropilot platform, we can provide predictive measurements, which are found in the FMR5X transmitters. Predictive measurements can be used to analyze process

changes before they become process upsets, resulting in a lost signal. In a typical example during agitation, foam can become present and increase to the point of signal loss.

### What is the advantage of the “non-contact” measurement aspects of Micropilot?

Non-contact is a very common customer preference. Because of the physics of the technology, there is nothing touching the process. Non-contact is typically preferred in dirty environments where contact with the product could require more excessive maintenance, and many of the processes cannot be shut down to remove transmitters for cleaning because of safety and runtime concerns. Chemicals utilized in water and wastewater plants can also be corrosive, which leans more toward a technology that is not in contact with them. The low cost and compact nature of the FMR10 and FMR20 non-contact radar device is the smallest and lightest radar transmitter of its kind in the industry. Level products in contact with the process can be more costly and cumbersome to install and maintain.

# How to slash energy costs with optimized aeration control

Utilities are under constant pressure to reduce costs, meet regulatory requirements, and improve sustainability. Finding the best way to meet these goals is a constant challenge.

Endress+Hauser has been helping water and wastewater utilities achieve their objectives for many years. They are a global leader in process automation and measurement. Endress+Hauser spoke with Water Online to discuss how to save energy in today's wastewater treatment facilities.

**Wastewater utilities are tasked with meeting stringent effluent limits, yet pressured to reduce costs. How can aeration control help to meet those goals?**

Control of the aeration process is critical to efficient operation of wastewater treatment plants. The impact of control is twofold, as both over- and under- aeration have detrimental effects. The energy wasted on over-aeration mounts quickly. The energy expended increases exponentially with increasing dissolved oxygen (DO) concentrations – and the impact on the biology can negatively impact the final effluent quality.

Automated control of the aeration process is an important energy conservation measure that greatly reduces energy usage by quickly

adjusting to variable conditions within the basin. The oxygen required for biological processes within the aeration basin is proportional to organic and ammonia loading in the influent wastewater. The most efficient control results in optimum removal of nutrients, carbon, and solids from the final product.

**What variables affect oxygen demand in wastewater treatment facilities?**

Plant designers try to maximize the oxygen transfer efficiency (OTE) under most operating conditions so that the plant will operate efficiently. OTE depends on a number of external factors including flow rate, water temperature, and site elevation. It decreases with increasing concentration of solids and surfactants. Within the basin itself, it increases from the inlet to the outlet as organic material is biodegraded.

**At many wastewater treatment plants, the operators manage aeration levels manually by running lab tests and turning the blowers on and off as needed. Is this the most cost-effective method of aeration control?**

In some facilities, wastewater treatment operators take field measurements to determine the DO concentration in the aeration basins.



Based on the results, operational modifications are made (e.g., to blowers or aeration system valves) to adjust the oxygen being delivered to the basins based on target set points. This is typically done only a few times (or once) per day and does not closely reflect diurnal variations in DO demand. In addition, a high safety factor is often applied to ensure that DO does not decrease below the target concentration, should the influent wastewater characteristics change quickly.

In order to more closely match the air delivered to the biological process oxygen demand, utilities commonly install automated control systems. Because the energy required increases exponentially with DO concentration, energy savings from automated DO control can be significant. Automated control systems measure real-time





DO or ammonium (or both) using probes located within the aeration basins. These measurements are used as inputs to a process controller that controls the blowers, resulting in a cost reduction.

**Can the problem of excessive blower operation be solved by installing variable frequency drives (VFDs) and DO meters in the system?**

It is common to find aeration control strategies based on a proportional, integral, derivative (PID) control loop. This traditional measurement loop uses a DO probe and transmitter combination to measure the amount of oxygen existing in the basin. This value is compared to the DO set point (between 2.0 to 4.5 mg/L). The required output is calculated and applied to the flow control valve to regulate the amount of air flowing into the tank, which changes the DO concentration in the basin.

While this application is capable of maintaining the DO within acceptable limits, the practice does not provide a solution to the low energy consumption requirements of today's modern plants.

This suggests that VFDs offer an efficient alternative for aeration control over traditional flow control valves.

When implementing a VFD strategy, flow control valves are removed from the system. The VFD, which is usually an integral part of the plant's motor control center, receives the output signal of the DO controller and in turn changes the speed of the air blower. The reduction in energy has been reported to be as much as 50 percent at 20 percent reduction of flow.

**Which parameters should be measured and controlled in order to obtain the most energy reduction while meeting permit requirements?**

Measured parameters at a minimum should be DO and flow, with the control determined by DO requirements.

However, the most effective strategy is to measure flow and DO and control with the ammonium measurement(s).

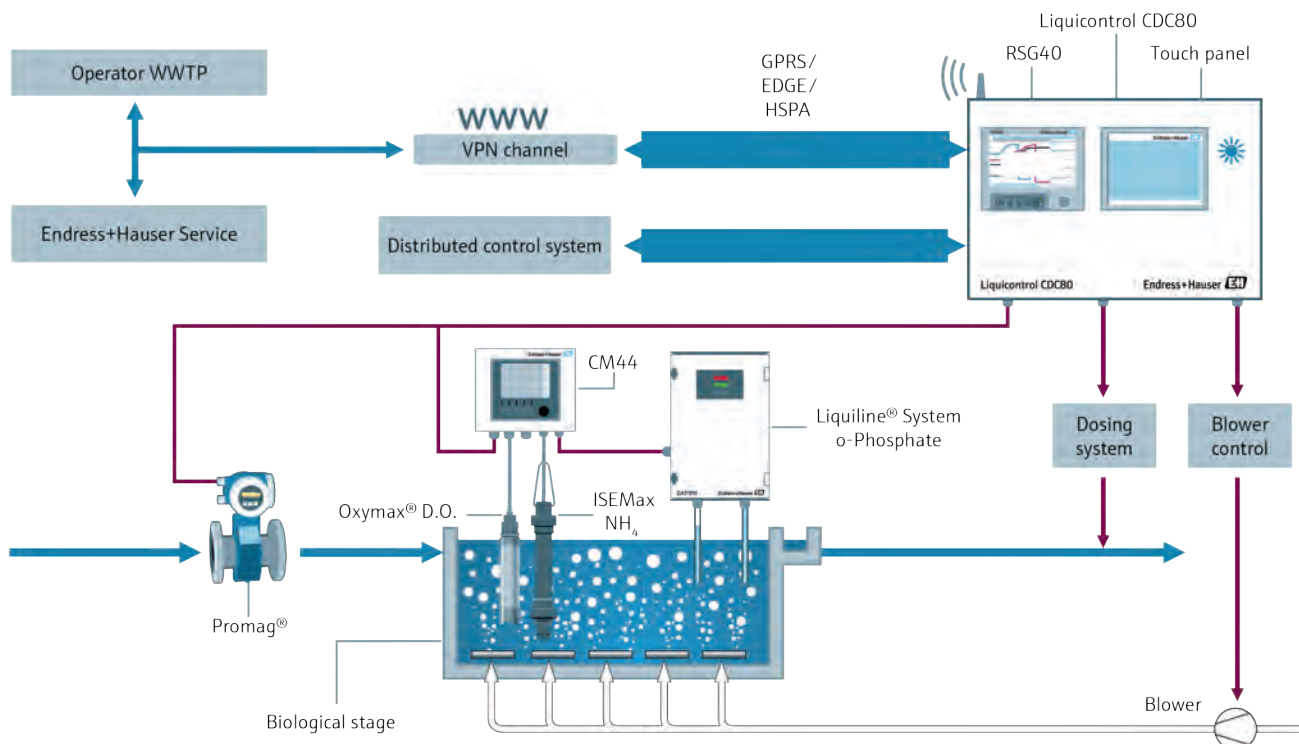

### How can aeration control help to meet nutrient limits?

As discharge permit requirements become stricter throughout the U.S., biological nutrient removal will become a necessity for most, if not all, plants. In order to operate the plant efficiently to meet regulatory compliance requirements, the removal of nitrogen, phosphorus, carbon, and solids can be attained most effectively by using continuous online analytical measurements and an optimized control strategy.

### Can aeration optimization help control the activated sludge process to reduce plant upsets?

In addition to wasting energy, over-aeration can cause poor sludge settling, increased foam, and have negative impacts on the anoxic zone of a biological nutrient removal (BNR) plant. Under-aeration can lead to underperformance of the activated sludge process and bulking issues. In some cases, under-aeration causes issues with struvite formation in sludge due to unwanted biological phosphorus removal. The best strategy to implement is one that provides good control over DO levels so that the aeration system supplies only what is needed.

### Can the aeration instrumentation be integrated with the plant's equipment and Supervisory Control And Data Acquisition (SCADA) system, and how long does it take to get everything working?

It depends on the plant, but an automated control system can be as simple as a feedback control loop that is manipulated in response to changes in DO. The system can use an on-off control strategy based on DO or ammonium. Automated control can also be a more complex system with multiple measurement technologies and proprietary algorithms, such as the Liquicontrol System by Endress+Hauser.

### Do the operators still have control over the process when aeration optimization is automated?

They can override the system if needed, but in reality, once the process is optimized during operation, they only need to monitor rather than interact with the control system on a daily basis.

### Does Endress+Hauser provide training and service for aeration control systems?

For our Liquicontrol System, Endress+Hauser offers commissioning, training, and optimization services for the aeration control platform. Customers who purchase field instrumentation only can have Endress+Hauser commission the devices and provide training. They will have the option of working with Rockwell Automation, our strategic business partner for control systems, to complete the aeration control system themselves.

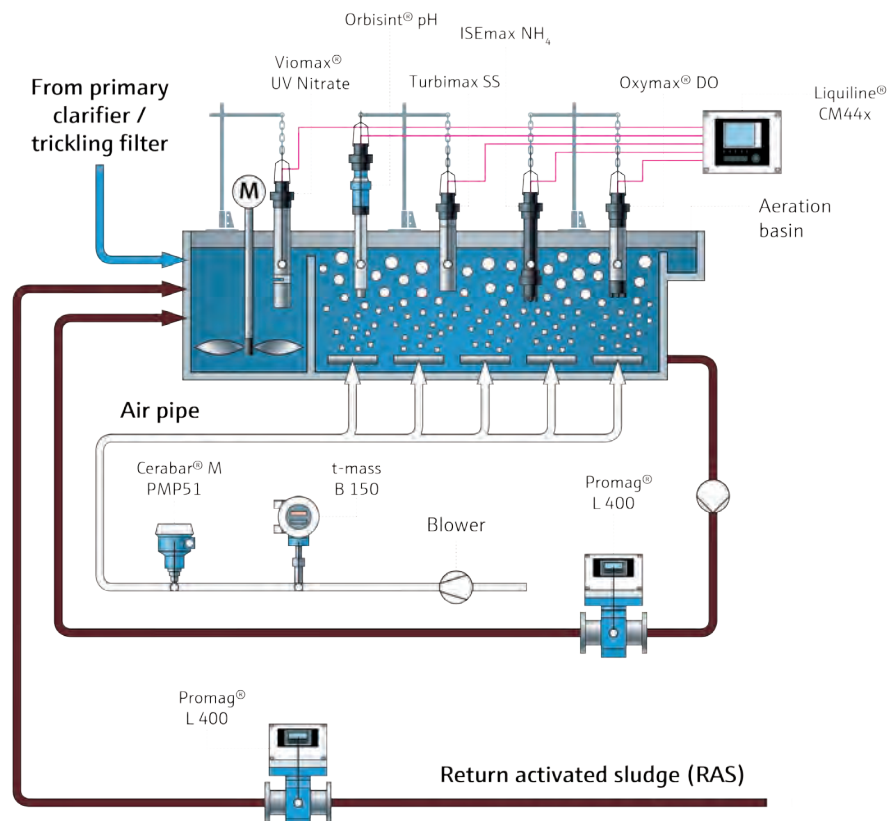
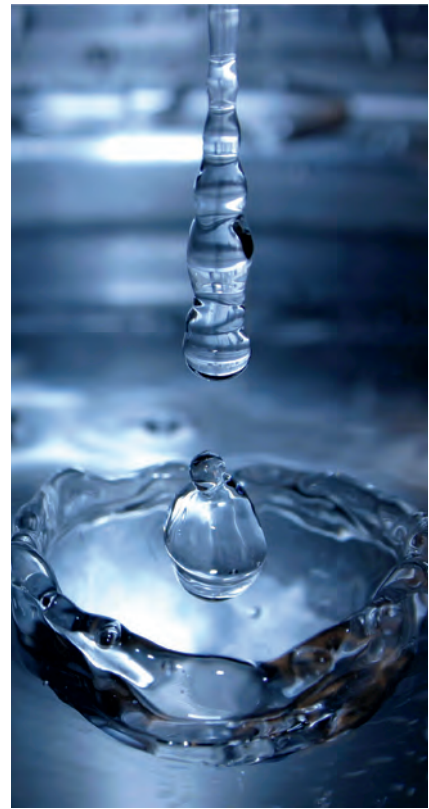

# We learn from the customers we serve

At Endress+Hauser, we are committed to continually improve our support for our customers. That's why every three years we implement a Customer Satisfaction Survey to identify what we are doing well, what improvements we can make and how we can serve you better. Thank you to all who participated in the latest survey, that was administered on our behalf by a globally respected business-to-business benchmarking company, TNS. Your feedback is valuable to us.



We're pleased to report that since the last survey, in 2013, we have made positive progress in all measurable areas and have significantly increased the number of customers who are highly satisfied with Endress+Hauser. After the last survey three years ago, Endress+Hauser put together a working group to address how we could improve customer satisfaction, based on the feedback received. After our survey results in 2013, we knew we needed to focus specifically on improving our handling of customer issues in an urgent way. A new complaint management process was implemented as a result. We also learned our notifications were not sufficient for our customers when there is an unexpected delay in

delivery time. We have made several changes in our organization to make this happen in a more efficient and timely manner. We also realized we needed more day-to-day feedback to help guide our improvements for our customers, so we implemented our Endresslistens.com platform.

In May 2016, we again worked with TNS to survey our customers. Our overall score (TRI\*M index) improved six points. Although this was a great result for us, our customers have let us know areas where we can still improve.

We know we must continue improving on how we respond when our customers experience issues. We have

to improve on providing a solution upon initial contact as well as the speed in which we handle these issues. Time is valuable when our customers are experiencing issues – we'll continue to work on making these improvements in this area. We will also be working with all of our customer support teams allowing us to have a better understanding of our customers' business and their industry so we can continue to improve as a partner for our customers.

Thank you for your continued feedback and support – and if there's anything we can do to improve your customer experience please let us know! You can give us feedback anytime at [www.Endresslistens.com](http://www.Endresslistens.com).





## Point level detection at the electrostatic precipitator

Providing point level switching for low dielectric fly ash

### Benefits at a glance

- Reliable long lasting point level detection
- Robust design and construction
- Ability to withstand high temperatures
- Eliminate flyash spillovers
- Risk Management for flyash handling and minimize potential financial consequences
- Potentially extend life of existing flyash handling systems

One pollution controlling process in fossil fuel burning facilities is the electrostatic precipitator to remove fly ash. The filters that capture the ash are mechanically shaken to cause the ash to fall into collection hoppers. It is necessary to have high level switches to indicate when the fly ash hoppers are full. Failure to have a reliable switch can cause damage to the surrounding equipment and plug the fly ash removal system – or worse lead to a hazardous spill. This application tends to be hot and abrasive. This causes issues for mechanical devices of the past. Endress+Hauser has the right solution to overcome these challenges.

### The challenge

**Environment in fly ash collection hoppers can be difficult.**

- Fly ash coats the hopper and is an abrasive material that can cause wear and tear of mechanical devices
- Dusty environment
- Temperatures can be in excess of 700°F
- Fly ash collected at one plant can be different from that collected at another, changing dielectric constants, densities and compositions

Early measurement techniques – mechanical systems – require high levels of maintenance as a result of the dusty environment.

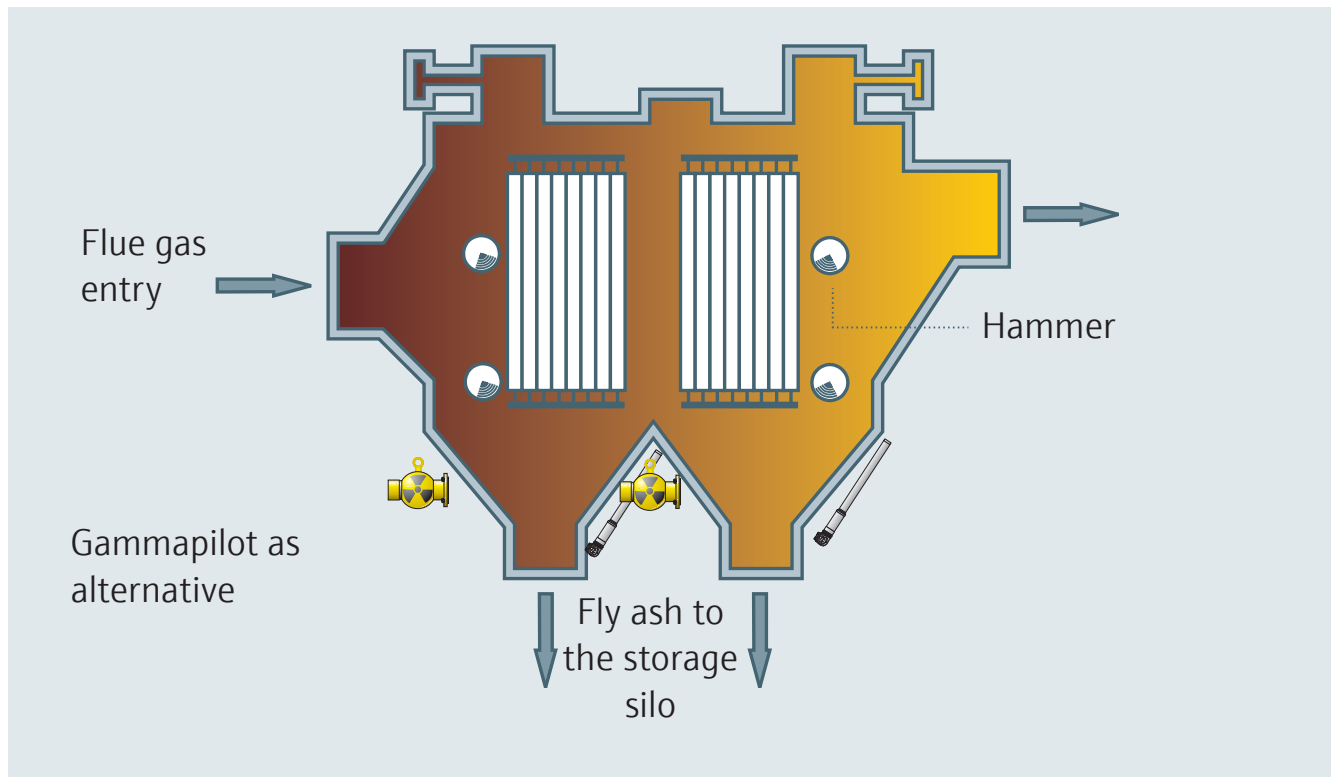

### Our solution

#### Solicap® FTI77 and Gammapiilot® FTG20

Endress+Hauser offers multiple level technologies to meet the demands of this application.

The Endress+Hauser capacitance probe FTI77 has:

- A robust design to withstand the wear and tear of fly ash
- Temperature insulator to withstand the high temperatures in the hopper
- Active build-up compensation so the coating from fly ash doesn't affect the measurement
- Large active plate area for more stable and reliable measurement – saving you time and money related to false-trips with other types of switches

The Endress+Hauser radiometric Gammapiilot is:

- Mounted externally to the hopper
- Unaffected by the build-up of materials at the bin walls
- Unaffected by high temperatures

### Conclusion

- Reliable solution ensures you can count on the measurement – no manual checking needed; save time and money
- Reduced maintenance costs
- Safety – prevention of overfills with reliable measurement

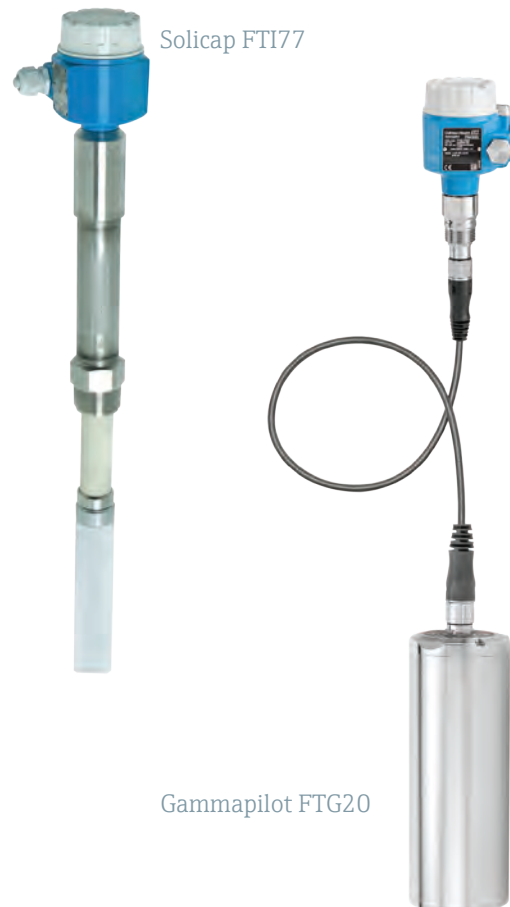

# Contributions to SIS process measurement risk and cost reduction

Advances in Endress+Hauser measurement and lifecycle management technologies can help safety system designers reduce risk and cost in their SIS designs and lifecycle management.

By Craig McIntyre and Nathan Hedrick, Endress+Hauser



Flowmeters like the one shown here can play key roles in reducing risks with safety instrumented systems (SIS)

Successful implementation and management of a safety instrumented system (SIS) requires designers and operators to address a range of risks. First, the specification of a proven measurement instrument and its proper installation for a given application is fundamental to achieving initial targeted risk reduction.

Second, definition of the support required to keep the instrument or other measurement subsystem available at that targeted level of risk reduction throughout the life of the SIS must be defined in the design and implementation phase.

Third, IEC 61511/ISA 84 provides “good engineering practice” guidance for SIS development and management. The new IEC 61511 edition 2 introduces some changes in these guidelines, strengthening emphasis on the requirements for end users to collect reliability data to qualify or justify specifications and designs.

## Sources of SIS measurement subsystem risks and costs

Under IEC 61508-ANSI/ISA 84, operators and SIS designers are required to qualify the appropriateness

of an SIS measurement subsystem to do its part in addressing an application-specific safety instrumented function (SIF). This includes the initial design of the SIS itself and the qualification of the measurement subsystem used in that service.

The assessment of data is used to qualify the use of measurement instruments in SIS applications. Even after this qualification, operational data and management of change (MOC) of these instruments over their lifetime in SIS applications must still be captured and assessed.

SIS measurement subsystems are typically exposed to adverse process and environmental conditions, so they tend to contribute a higher risk to availability than a safety controller, which is normally installed in a controlled environment.

## Risk from probabilistic failure sources

Risk of failure to perform an expected function can come from probabilistic/random failure sources; for example, the collective probabilistic failures of electronic components in a transmitter. Required maintenance and random proof test procedures must be determined and executed to keep the probability of failure on demand (PFD) and lambda dangerous undetected ( $\lambda_{du}$ ) fault risk that is outside the reach of diagnostics below a required average risk reduction target.



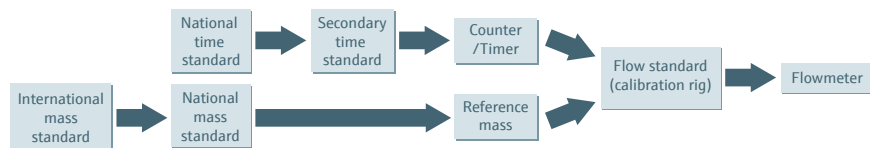

**FIGURE 2.** The figure shows a traceability chain for a mass flowmeter

One can seek to address this risk by employing measurement devices contributing low  $\lambda_{du}$ . Measurement devices with lower  $\lambda_{du}$  values give system designers greater freedom to set longer proof test intervals as these contribute a lower increase in PFD over time.

For example, the Promass 200 Coriolis flowmeter may have  $\lambda_{du}$  values of 73 FIT. All other things being equal, a measurement subsystem with half the  $\lambda_{du}$  FIT could allow doubling the random proof test interval.

### Risk from systematic failure sources

Risk of failure to perform an expected function can also come from systematic failure sources; for example, human or process damage to a sensor. Systematic fault risk may be created by process medium properties or operating conditions. Periodic visual field inspections, calibrations and maintenance can introduce risk. There is some measure of risk from (and to) personnel who need to follow written procedures to conduct activities in the field and work with instruments that may need to be removed, transported, repaired, tested and reinstalled.

It has been stated by a Top Five chemical company that “2% of every time we have human intervention we create a problem.” Another leading specialty chemical company conducted a study that concluded “4% of all devices which are proof tested get damaged during re-installation.” Reducing the need for personnel to physically touch a measurement subsystem offers designers a capability to reduce some systematic failure risk to a SIS.

IEC 61511 edition 2 points to the need to specify in the safety requirements specification (SRS) the methods and procedures required for testing SIS diagnostics.

Measurement subsystems using Heartbeat Technology™ can conduct continuous availability monitoring and provide periodic reports. This means a measurement subsystem may not only have high diagnostic coverage, but also redundancy—meaning the testing functions are redundant and continuously checking each other.

### In situ traceable calibration verification

Verification and documentation to prove the SIS subsystem calibration is acceptable normally requires removal of the subsystem. This exposes the instrument to damage during removal, transport and reinstallation. There is also risk for unrealized damage or error introduction due to process shutdowns/startups often required when an instrument is removed from service.

The measurement subsystem may need to be calibrated or verified with traceability to an international standard. If an organization is ISO 9001:2008 certified, it needs to address Clause 7.6a Control of monitoring and measuring devices which states: “Where necessary to ensure valid results, measuring equipment shall be calibrated or verified at specified intervals, or prior to use, against measurement standards traceable to international or national measurement standards.”

Heartbeat Verification offers a test method that does not require removal of the instrumentation or interruption of the process because the verification functionality is embedded in the device.

Using redundant, internal, and traceable references for a cross-check is a unique capability of this built-in technology. The validity of this approach has been attested to by independent third-party TÜV which states, “Heartbeat Technology™ complies with the requirements for traceable verification according to DIN EN ISO 9001:2008 – Section 7.6a).”

### Summary

Implementation of a SIS requires process risk protection to a targeted minimum while maintaining design and lifecycle costs at a reasonable level. Instruments with Heartbeat Technology™ and lifecycle management tools can help process plant personnel reduce risks and costs associated with a SIS system. They can also aid in capturing reliability data.

Instrumentation suppliers like Endress+Hauser who serial-number their components are able to provide operators a real time Cloud- or enterprise-based connection between the measurement device in the field and serial number based support documentation, certificates, history, changes and calibration information. This can help reduce the time required to obtain needed information, as well as reduce the risk of using the wrong information.

 To view full article visit: [us.endress.com/managing-SIS](https://us.endress.com/managing-SIS)





# Improve your brewery without breaking the bank

Smaller breweries benefit from instrumentation in the same way as larger operations. The challenge is to know where to start and how to justify the initial expense. Endress+Hauser supports small as well as large scale breweries with high quality measurement solutions that are scalable to your needs.

All breweries need the critical information about their brewing process. The first challenge for a smaller operation is to achieve stable quality. This includes the amount of water they use in mashing and sparging as well as how much wort or beer is moved in the brewery or cellar.

A basic magnetic flowmeter mounted on a cart with standard Tri-Clamp® connections make this measurement easy. Use the onboard totalizer or add a batch controller to easily monitor your batches.

High accuracy temperature sensors in the brew house and fermenter ensure stable production conditions. For the kettle, mash tun and fermentation tank, temperature sensors connected to a simple display/recorder allow you to monitor and record your batches for repeatability.



## Promag H - magnetic flowmeter

- Preferred sensor for hygienic applications with highest requirements in the Food and Beverage industry
- Standard sizes ½ up to 6"
- [www.us.endress.com/5H5B](http://www.us.endress.com/5H5B)



## Ecograph T RSG35

- 6 channel display/recorder lets you do basic controls and collect the measurement information in digital format
- Ethernet output lets you import all your brewing data to your planning or management software
- [us.endress.com/rsg35](http://us.endress.com/rsg35)



## Easytemp - TMR35

- Simple, cost effective and self contained ultra fast and accurate measurement you can trust for many years
- [www.us.endress.com/TMR35](http://www.us.endress.com/TMR35)



## Liquiphant FTL33

- Point level switch for liquids, no calibration or adjustment needed
- Liquid empty pipe detection switch protects your pump from running dry
- [us.endress.com/FTL33](http://us.endress.com/FTL33)



## Smartec CLD18

- CLD18 conductivity sensor is a simple way to determine if you have wort, beer, water or CIP in the line, it can also be used to determine the concentration of the CIP detergents
- Local display lets you see what's in the tank or pipe
- [us.endress.com/CLD18](http://us.endress.com/CLD18)





Give us your feedback:  
[www.endresslistens.com](http://www.endresslistens.com)



**USA**

Endress+Hauser, Inc.  
2350 Endress Place  
Greenwood, IN 46143  
Tel: 317-535-7138  
888-ENDRESS  
(888-363-7377)  
Fax: 317-535-8498  
info@us.endress.com  
www.us.endress.com

**Other Locations**

For other locations  
visit: [www.addresses.endress.com](http://www.addresses.endress.com)

CM011332/EN/01.17  
(01.2017)  
© Endress+Hauser, Inc., 2017