

Visitor Guide

Houston, Texas



Content

| | |
|---|----|
| Content | 2 |
| Welcome | 3 |
| Houston Campus and Directions..... | 4 |
| Hotel Information..... | 6 |
| George Bush Intercontinental Airport..... | 8 |
| William P Hobby Airport | 10 |
| Rental Cars and Taxi Services..... | 12 |
| Firearm Carry Act of 2021 | 13 |
| Dress Code..... | 13 |
| Dining | 14 |
| Local Attractions | 16 |

Welcome!

We are pleased to welcome you to Texas. For questions regarding your visit, please contact Elyse Paalz.

Elyse Paalz
Endress+Hauser USA, Event Coordinator
+1 317-751-6005
Cell: +1 281-806-8451
elyse.paalz@endress.com

Endress+Hauser USA Customer Center
Vector CAG Customer Center
AnalytikJena
14525 Kirby Drive, Pearland, TX 77047

Linda Goodrich
Vector Controls and Automation Group, Marketing Director
+1 800-969-5678
Cell: +1 713-204-0005
Linda.goodrich@vectorcag.com

Endress+Hauser USA
Vector CAG
AnalytikJena
14517 Kirby Drive, Pearland, TX 77047



Campus Map

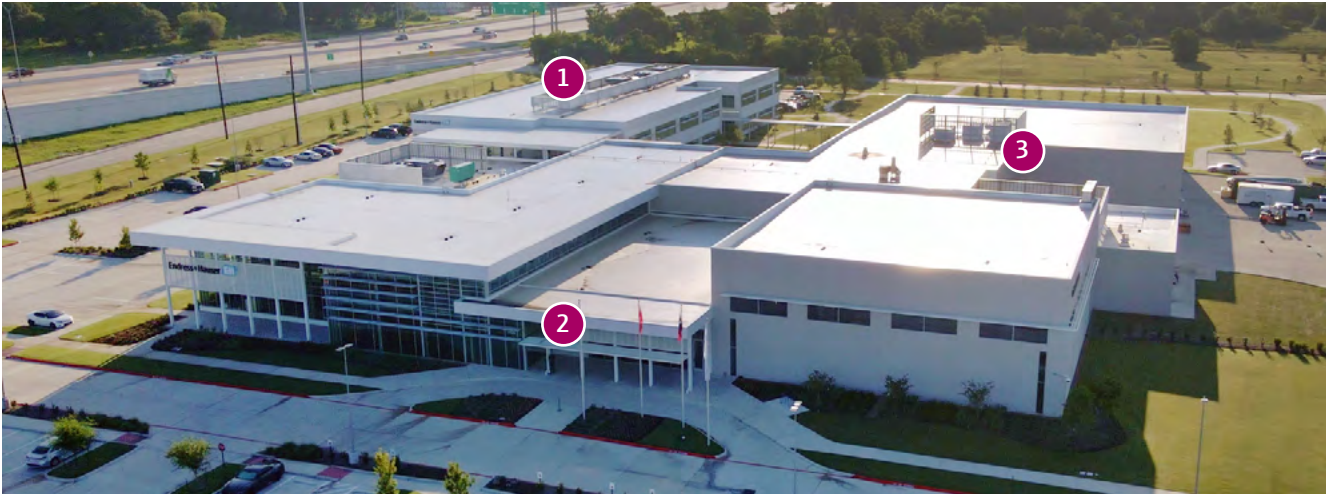

1 Endress+Hauser USA
 Vector CAG
 AnalytikJena
 14517 Kirby Drive, Pearland, TX 77047

2 Endress+Hauser USA Customer Center
 Vector CAG Customer Center
 AnalytikJena
 14525 Kirby Drive, Pearland, TX 77047

3 Vector CAG Integration Center
 14535 Kirby Drive, Pearland, TX 77047

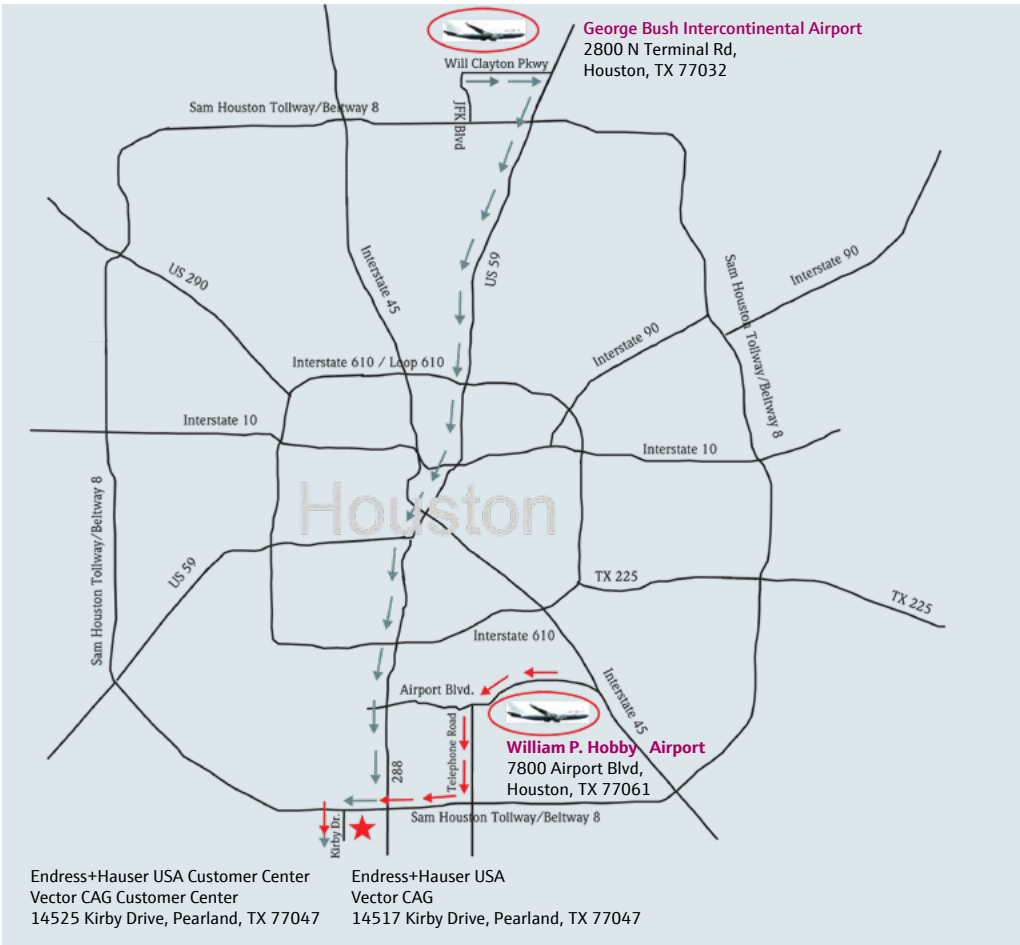

Directions to/from Houston Airports to Campus

To Campus from George Bush Intercontinental Airport (IAH)

- From Airport, head West onto Jetero Blvd/Will Clayton Pkwy
- Turn left toward Jetero Blvd/Will Clayton Pkwy
- Turn left at the 1st cross street onto Jetero Blvd/Will Clayton Pkwy
- Continue onto Will Clay Pkwy
- Turn right onto 4th St/Eastex Freeway Service Rd
- Use the left lane to take I-69/U.S. 59 S ramp
- Merge onto I-69
- Take exit 128B to merge onto State Hwy 228 S/TX-288 S toward Lake Jackson/Freeport
- Keep right at the fork, continue onto State Hwy 288 S
- Take the exit toward State Hwy 288 S
- Exit onto South Freeway
- Turn right onto W Belfort Ave
- Turn left onto Knight Rd
- Turn right at the 1st cross street onto Holmes Rd
- Turn right onto Kirby Dr.
- Arrive at 14525 Kirby Dr. or 14517 Kirby Dr., Pearland, TX 77047

To George Bush Intercontinental Airport (IAH) from Campus

- From campus, head north on Kirby Dr. toward Cross Point
- Turn right onto S Loop W
- Merge onto I-610 E
- Take Exit 38A for TX-288 N toward Downtown
- Continue onto State Hwy 288N/TX-288 N
- Take exit toward Elgin Ave/Tuam Ave
- Merge onto I-69/US-59N
- Keep left to continue onto I-69
- Take Exit 144 onto TX-8 Beltway W/N Sam Houston Pkwy E W
- Take the exit toward JFK Blvd
- Merge onto N Sam Houston Pkwy E/Texas 8 Beltway Frontage Rd
- Take a slight right onto John F Kennedy Blvd
- Arrive at George Bush Intercontinental Airport, 2800 N Terminal Rd, Houston, TX 77032

To Campus from William P. Hobby Airport (HOU)

- From Airport, turn left onto Airport Blvd
- Turn right onto Mykawa Rd
- Turn left onto Belford Ave
- Turn left onto Knight Rd
- Turn right at the first cross street onto Holmes Rd
- Turn right onto Kirby Dr.
- Arrive at 14525 Kirby Dr. or 14517 Kirby Dr., Pearland, TX 77047

To William P. Hobby Airport (HOU) from Campus

- From campus, head north on Kirby Dr toward Cross Point
- Turn right onto S Loop W
- Merge onto I-610 E
- Take Exit 32A to I-45S towards Hobby Airport/Galveston
- Take Exit 39, Park Pl Blvd/Broadway Blvd
- Merge onto Gulf Freeway
- Continue straight onto Broadway ST
- Exit left toward Hobby Airport
- Merge onto Hobby Airport Loop
- Arrive at William P. Hobby Airport, 7800 Airport Blvd, Houston, TX 77061

Hotel Information

Near Campus

[Hilton Garden Inn Houston-Pearland](#)

12101 Shadow Creek Pkwy,
Pearland, TX 77584
Telephone: 713-340-0110

Preferred Rate

Hotel Amenities and Services

- Free WiFi
- Free Parking
- Outdoor Pool
- Fitness Center
- Business Center
- Digital Key



[Courtyard by Marriott Houston Pearland](#)

11200 Broadway St Ste. 200,
Pearland, TX 77584
Telephone: 713-413-0500

Hotel Amenities and Services

- Smoke-Free property
- Fitness Center
- Outdoor Pool
- Business Center



[SpringHill Suites by Marriott Houston Pearland](#)

1820 Country Place Pkwy,
Pearland, TX 77584
Telephone: 713-436-7377

Hotel Amenities and Services

- Free breakfast
- Smoke-Free property
- Fitness Center
- Outdoor Pool
- Free Parking
- Business Center



[Holiday Inn Express & Suites Pearland](#)

1702 N Main St,
Pearland, TX 77581
Telephone: 281-997-2600

Hotel Amenities and Services

- Smoke-Free property
- Free breakfast
- Business Center
- Outdoor Pool
- Fitness Center
- Free parking



[Home2 Suites by Hilton Houston Pearland](#)

13923 South Fwy,
Houston, TX 77047
Telephone: 346-446-4700

Hotel Amenities and Services

- Free WiFi
- Free breakfast
- Non-Smoking Rooms
- Free parking
- Fitness Center
- Outdoor Pool
- Business Center



George Bush Intercontinental Airport (IAH)

George Bush Intercontinental Airport (IAH) was ranked as Best U.S. Airport, Second-Best in North America at World Airport Awards. IAH is one of two Houston-area airports — offering flights, domestically and internationally, on most major airlines. George Bush Intercontinental Airport is located north of downtown Houston, approximately 40 minutes from the campus.

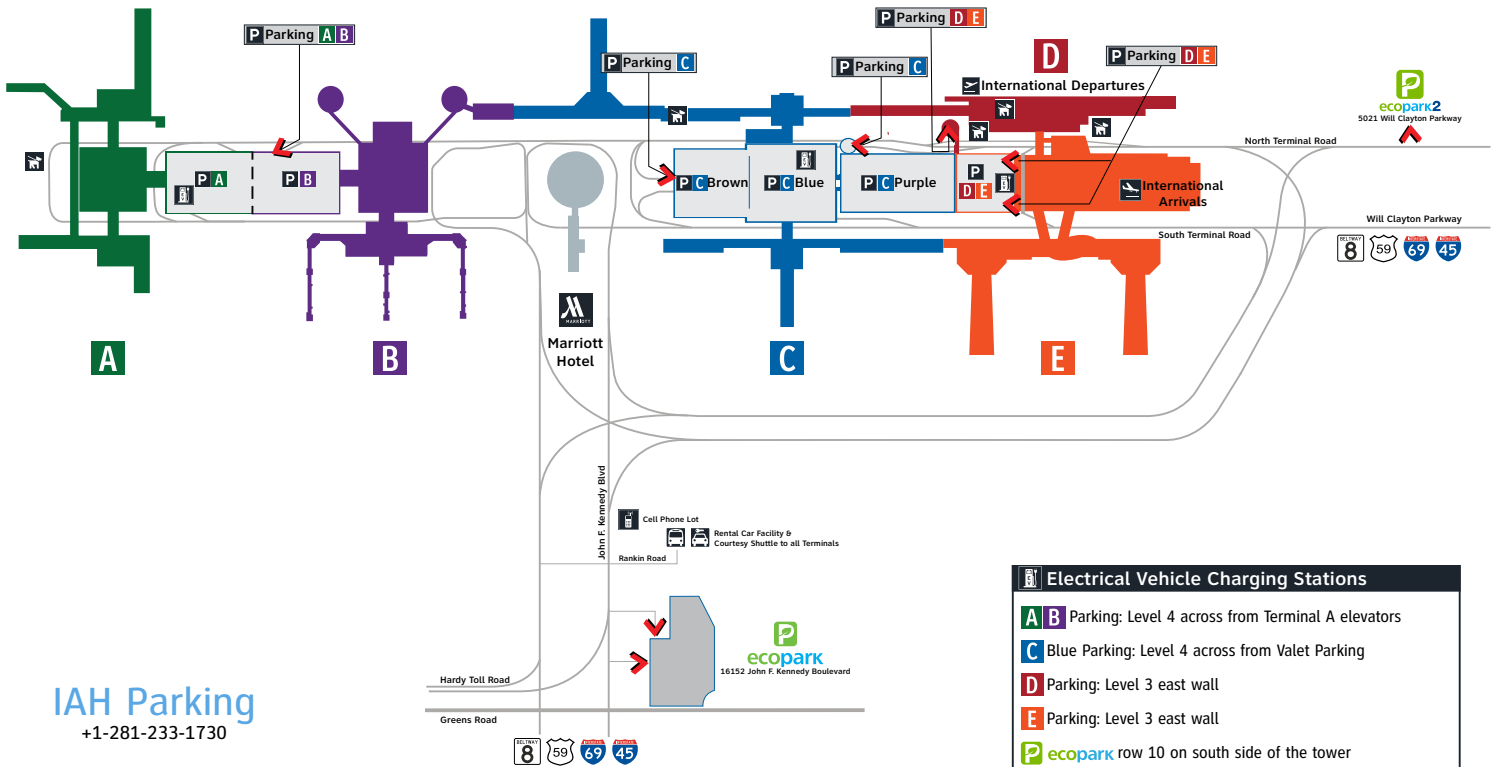

IAH Parking
+1-281-233-1730

| Electrical Vehicle Charging Stations | |
|--------------------------------------|---|
| A B Parking | Level 4 across from Terminal A elevators |
| C Blue Parking | Level 4 across from Valet Parking |
| D Parking | Level 3 east wall |
| E Parking | Level 3 east wall |
| P ecopark row 10 | on south side of the tower |
| P ecopark2 | centrally located near ecopark2 office building |

➤ Parking Entrance

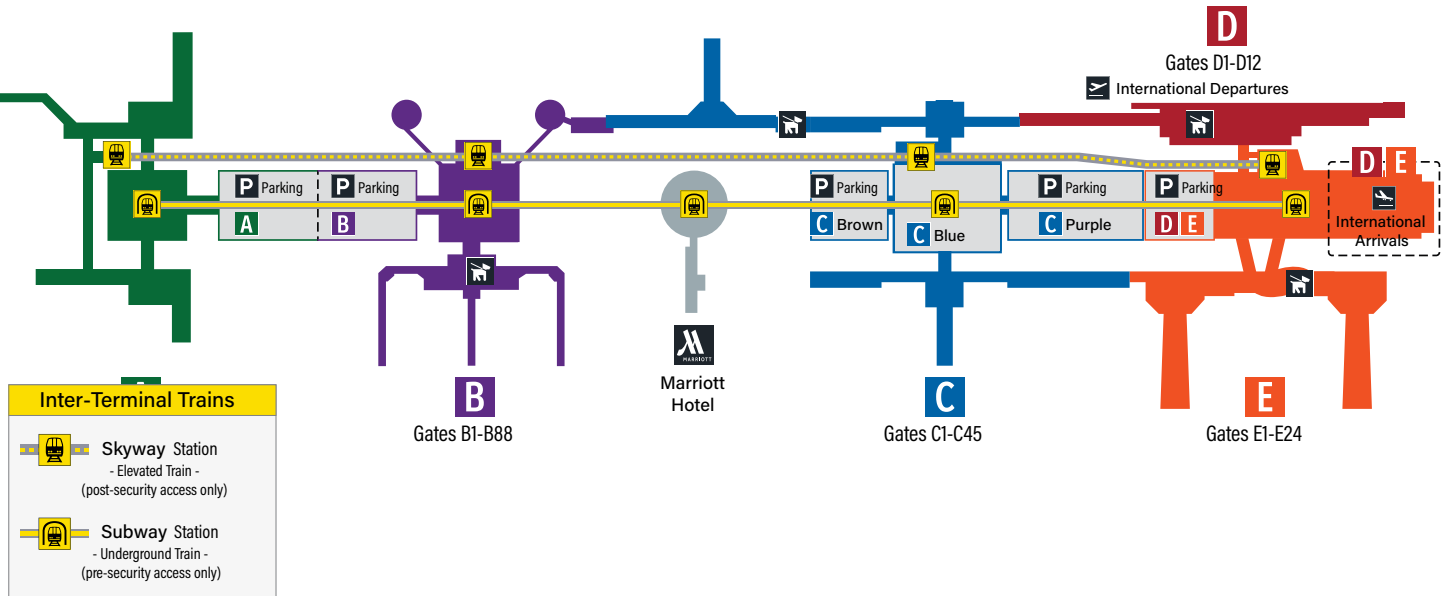

| Inter-Terminal Trains | |
|-----------------------|--|
| | Skyway Station - Elevated Train - (post-security access only) |
| | Subway Station - Underground Train - (pre-security access only) |

| Terminal A | |
|--|---|
| Airlines - Air Canada - WestJet - Alaska Airlines - American - Boutique Air - Delta - Frontier - JetBlue - Spirit - United | Lounges - American Airlines Admirals Club (A25) - United Club (A9) |
| Amenities & Services - Airport Information Booth - ATM - Baggage Carts - Baggage Wrap - Electrical Charging Stations - Harmony in the Air - Interactive Visitor Kiosks - Mailbox - MailSafe Express - Massage Chairs | - Mothers Rooms - Rapid Charger Machines (\$) [†] - Service Animal Relief - Shoe Shine - Telephones - TTY Phones - Vending Machines - Water Bottle Filling Stations |
| Shopping - Benefit Cosmetics Automated Kiosk - Best Buy Express Automated Kiosk - Brookstone - City Point - Culturemap - CVS Automated Kiosk - Dylan's Candy Bar - EarPlanes Automated Kiosk - FuelRod SwapBox Kiosk - Houston Chronicle - Houston! - KPRC 2 Travel Store - Texas Monthly News** - Trip Advisor - XpresSpa | Dining ^{†full service} ^{**grab & go options} - Blaze Pizza - Cadillac Mexican Kitchen & Tequila Bar* - Chick-fil-A - Hubcap Grill & Beer - Jack in the Box - Liquid Provisions* - Mockingbird Distillery & Smokehouse* - Panda Express - Starbucks** - SUBWAY - The Breakfast Klub* - The Breakfast Klub Express - Vending Machine-Coffee - Wendy's - Which Wich |

| Terminal B | |
|--|---|
| Airlines - United | Lounges - United Club (Mezzanine Level) |
| Amenities & Services - ATM - Baggage Carts - Currency Exchange - Electrical Charging Stations - Interactive Visitor Kiosks - MailSafe Express - Massage Chairs - Mothers Rooms | - Nursery - Rapid Charger Machines (\$) [†] - Service Animal Relief - Shoe Shine - Telephones - TTY Phones - Vending Machines - Water Bottle Filling Stations |
| Shopping - Allen's Landing - Brookstone - CVS Automated Kiosk - Duty Free Store - FuelRod SwapBox Kiosk - iStore - iStore Boutique - Johnston & Murphy - Natalie's Candy Jar - Rocky Mountain Chocolate Factory - Spanx - Spirit of the Red Horse - Sunglass Icon - The Body Shop - The Wall Street Journal - Univision | Dining ^{†full service} ^{**grab & go options} - 3rd Bar Eating House* - American Craft Tavern** - BarCuterie* - Bullritos - Cafe Adobe*** - CIBO Express Gourmet Market** - Chick-fil-A - El Real - Freshii - Hard Rock Cafe* - Jason's Deli - Panda Express - Peet's Coffee** - Starbucks** - Tagliare** - The Fruteria* - Whataburger |

| Terminal C | |
|--|---|
| Airlines - United | Lounges - United Club (C1), (C33) |
| Amenities & Services - Airport Information Booth - ATM - Baggage Carts - Chapel - Currency Exchange - Electrical Charging Stations - Interactive Visitor Kiosk - Mailsafe Express - Massage Chairs - Mothers Rooms | - Nursery - Rapid Charger Machines (\$) [†] - Service Animal Relief - Shoe Shine - Telephones - TTY Phones - UA Lost & Found - Vending Machines - Water Bottle Filling Stations |
| Shopping - Adrenaline - Bayou City Travelmart - Benefit Cosmetics Automated Kiosk - Best Buy Express Automated Kiosk - Brooks Brothers - CNBC Smartshop - Culturemap - FuelRod SwapBox Kiosk - Houston! - James Avery - Jo Malone London - Kiehls - KPRC 2 Travel Store - M.Fredric - MAC - Made.Texas - Pinto Ranch - Rip Curl - Rocky Mountain Chocolate Factory - Simply Books - Soundbalance - Space Corner - Sunglass Hut - Sunglass Icon - Swarovski - Texas Monthly News** - TUMI - Univision - Victoria's Secret | Dining ^{†full service} ^{**grab & go options} - Agave Taqueria - Bam Bam*** - Brewster Beer Garden - Camden Food Co.** - CIBO Express Gourmet Market** - CIBO Express Gourmet Market/World Bean** - Einstein Bros. Bagels** - El Premio Tex-Mex Bar & Grill* - Ember* - Forno Magico Neapolitan Pizza* - Freshens - H-Burger Bar* - La Salsa - Landry's Seafood* - Olio* - Pala* - Pick Up Stix - Pink's Pizza - Pottbelly Sandwich Shop - Southern Belle* - Starbucks** - Stax - SUBWAY - Vida Taqueria* - Wendy's |

| Terminal D | |
|--|---|
| Airlines - Aeromexico - Air China - Air France - Air New Zealand - All Nippon Airways (ANA) - Avianca - British Airways - Emirates - Ethiopian Airlines - EVA Air - Interjet - KLM Royal Dutch Airlines - Lufthansa - Qatar Airways - Singapore Airlines - Turkish Airlines - VivaAerobus - Volaris | Lounges - Air France Lounge (D12) - British Airways Lounge (D8) - KLM Crown Lounge (D8) - The Centurion® Lounge by American Express (Mezzanine Level) - USO (D2) Executive Club (D5): - Air China - Emirates - EVA Air - Lufthansa - Qatar Airways |
| Amenities & Services - Airport Information Booth - ATM - Baggage Carts - Baggage Wrap - Chapel - Currency Exchange - Electrical Charging Stations - Harmony in the Air - Interactive Visitor Kiosks - Nursery | - Massage Chairs - Rapid Charger Machines (\$) [†] - Service Animal Relief - Tax Rebates - Telephones - TTY Phones - Vending Machines - Water Bottle Filling Stations |
| Shopping - AT Ü Duty Free - Best Buy Automated Kiosk - Chanel - Corsa Collections - FuelRod SwapBox Kiosk - PANDORA - TUMI - UNIQLO Automated Kiosk - Univision | Dining ^{†full service} ^{**grab & go options} - Ciao Gourmet Market** - Hugo's Cocina* - Peet's Coffee** - Red Mango - Starbucks** - Tony's Wine Cellar & Bistro* - Vending Machine-Coffee - Vending Machine-Hot Water |

| Terminal E | |
|--|--|
| Airlines - United | Lounges - United Club (E12) - United Polaris Lounge (E12) |
| Amenities & Services - Airport Information Booth - ATM - Baggage Carts - Currency Exchange - Electrical Charging Stations - Global Entry - Interactive Visitor Kiosks - Lost & Found Office - MailSafe Express - Massage Chairs | - Mothers Rooms - Rapid Charger Machines (\$) [†] - Service Animal Relief - Shoe Shine - Tax Rebates - Telephones - TTY Phones - Vending Machines - Water Bottle Filling Stations |
| Shopping - Americana - Benefit Cosmetics Automated Kiosk - Best Buy Express Automated Kiosk - Briggs & Riley - Brookstone - CVS Automated Kiosk - Dufry Tax & Duty Free - Eddie Bauer - Forth & Nomad - Headphone Hub - InMotion Entertainment - Johnston & Murphy - L'Ocitanie - Mindworks - My Sweets - NYS Collection - Skyroam Automated Kiosk - Soundbalance - Space Corner - Sports Corner - Stance Automated Kiosk - Sunglass Hut - Swatch - Taxco Sterling Co. - The Wall Street Journal - UNIQLO Automated Kiosk - U.S. News & World Report | Dining ^{†full service} ^{**grab & go options} - Auntie Anne's - Beehive* - Cat Cora's Kitchen* - CIBO Express Gourmet Market** - Cinnabon - Custom Burgers - Doubler Beer & Whiskey Garden* - Dunkin' Donuts - Einstein Bros. Bagels - Gavi* - Houston Wheelhouse* - Nature's Kitchen - Nestlé Toll House Café - Panda Express - Pappadeaux Seafood Kitchen* - Pappasito's Cantina - Q* - Ruby's Diner*** - Starbucks** - Tagliare - Tanglewood Grille* - The Market by Villa - Wendy's - World Nectar - Yogen Fr üz - Yume*** - Zori Bistro |

William P. Hobby Airport (HOU)

William P. Hobby Airport (HOU) airport offers flights, domestic and international, via 3 major airlines – American Airlines, Delta, and Southwest. HOU is the closest Houston-area airport option, located approximately 20 minutes from our campus.

Level 1 – Arrivals

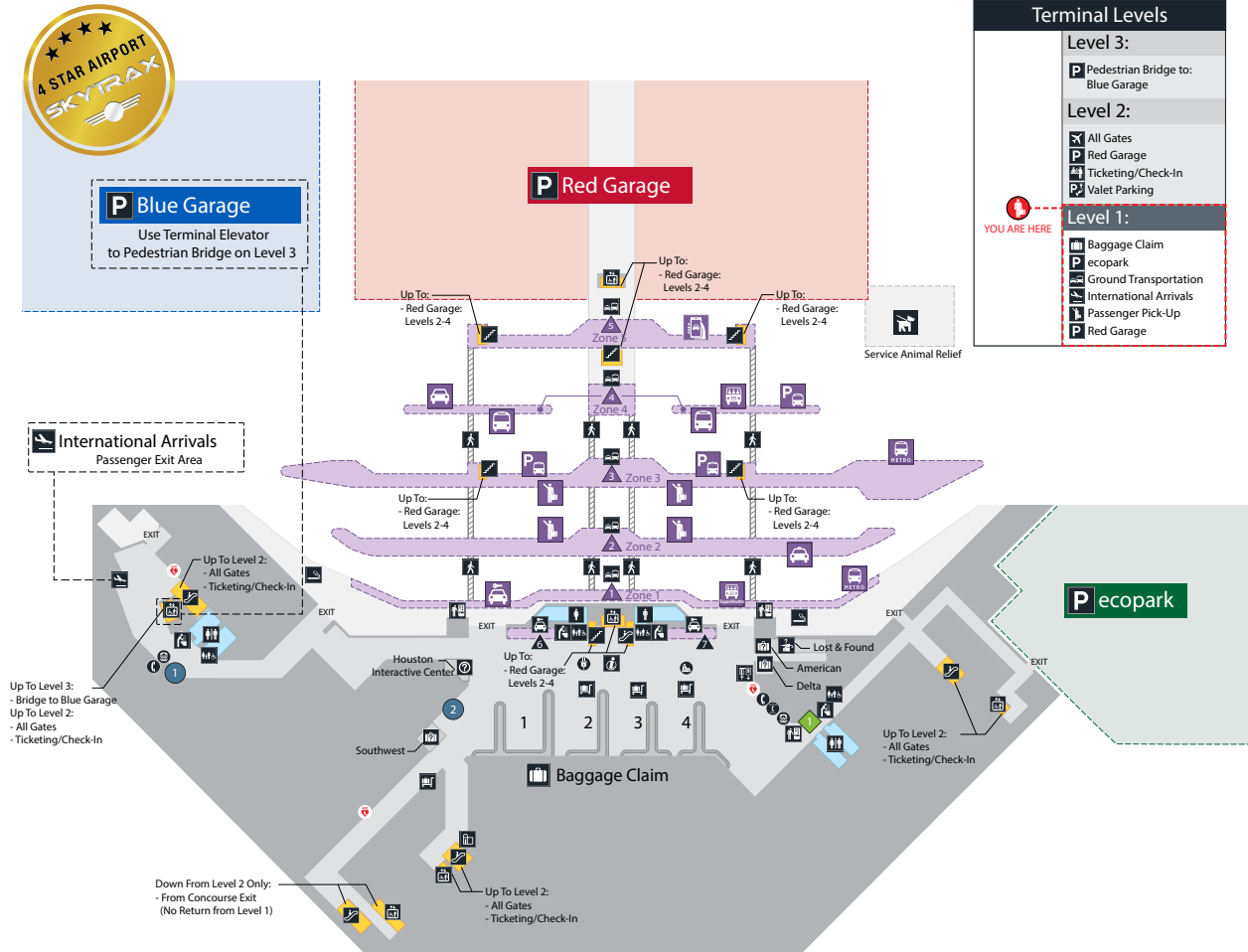

| Amenities & Services | Baggage Carousels | Ground Transportation | Dining |
|---|--|--|---|
| <ul style="list-style-type: none"> AED ATM Baggage Carts Baggage Claim Baggage Services Chapel Courtesy Phones Elevators Escalators Family Restrooms Houston Interactive Center Interactive Visitor Kiosks International Arrivals Lost & Found Massage Chairs Parking Pedestrian Crosswalk Rapid Charger Machines (5) Restrooms Service Animal Relief Smoking Area Stairs Telephones TTY Phones Valet Parking Vending Machines Water Bottle Filling Stations | <ul style="list-style-type: none"> Carousels 1 & 2: <ul style="list-style-type: none"> - Southwest Carousels 3 & 4: <ul style="list-style-type: none"> - American Airlines - Delta - Southwest | <ul style="list-style-type: none"> Zone 1: <ul style="list-style-type: none"> METROLift Rental Car Shuttles SuperShuttle Zone 2: <ul style="list-style-type: none"> Passenger Pick-Up Taxis Zone 3: <ul style="list-style-type: none"> Hotel/Motel Shuttles METRO Buses Off-Airport Parking Shuttles Passenger Pick-Up Zone 4: <ul style="list-style-type: none"> Charter Bus Limos Off-Airport Parking Shuttles Shared Ride Shuttles Zone 5: <ul style="list-style-type: none"> Ride App Pickup: <ul style="list-style-type: none"> - Get Me - GreenLight (GLT) - Lyft - Uber - Wingz Rental Car Counters: <ul style="list-style-type: none"> - Avis - Budget - Dollar - Enterprise Rental Car Counters: <ul style="list-style-type: none"> - Alamo - Hertz - National - Thrifty | <ul style="list-style-type: none"> Vending Machine-Coffee <p>Shops</p> <ul style="list-style-type: none"> 1 Culturemap 2 H-Town |

Level 2 – Departures

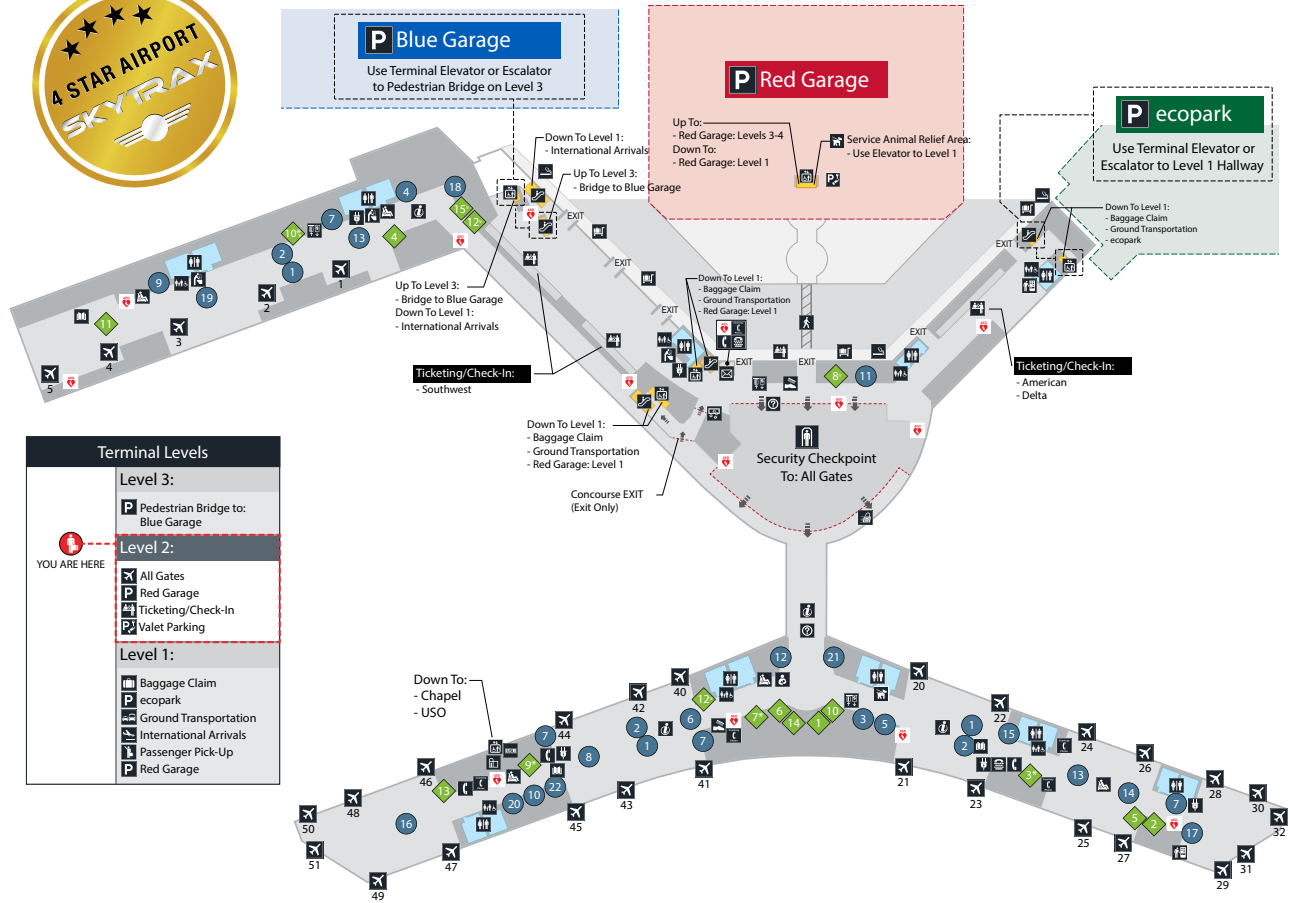

| Terminal Levels | |
|---------------------|-------------------------------------|
| | Level 3: |
| | P Pedestrian Bridge to: Blue Garage |
| YOU ARE HERE | Level 2: |
| | All Gates |
| | P Red Garage |
| | Ticketing/Check-In |
| | P Valet Parking |
| | Level 1: |
| | P Baggage Claim ecopark |
| | Ground Transportation |
| | International Arrivals |
| | Passenger Pick-Up |
| | P Red Garage |

Amenities & Services

- AED
- Airport Information Booths
- ATM
- Baggage Carts
- Chapel
- Courtesy Phones
- Curbside Check-in
- Currency Exchange
- Elevators
- Escalators
- Family Restrooms
- Gates
- Interactive Directories
- Mailbox
- MailSafe Express
- Mother's Room
- Little Library
- Massage Chairs
- Pedestrian Crosswalk
- Rapid Charger Machines (S)
- Restrooms
- Security Checkpoint
- Service Animal Relief Area
- Shoe Shine
- Smoking Area
- Stairs
- Telephones
- Ticketing/Check-In
- TTY Phones
- USO
- Valet Parking
- Vending Machines
- Water Bottle Filling Stations

Dining

- 1** Barry's Pizza
- 2** Baskin-Robbins
- 3** Buffalo Wild Wings*
- 4** Chick-fil-A
- 5** Dunkin' Donuts
- 6** Hunan Return of the Phoenix
- 7** Pappadeaux Seafood Kitchen*
- 8** Pappas Bar-B-Q*
- 9** Pappas Burger*
- 10** Pappasito's Cantina*
- 11** Pappasito's Cantina (Bar)
- 12** Peet's Coffee & Tea*
- 13** Subway
- 14** Wendy's
- 15** Via Via Mary's*

Shopping

- 1** Benefit Cosmetics Automated Kiosk
- 2** Best Buy Express Automated Kiosk
- 3** CNBC Smartshop
- 4** Desigual
- 5** Dylan's Candy Bar
- 6** Executive Style Jewelry
- 7** FuelRod SwapBox Kiosk
- 8** HMart
- 9** Houston Chronicle
- 10** iStore
- 11** KPRC 2 Travel Store
- 12** MAC
- 13** My Sweets
- 14** NYS Collection
- 15** PGA Tour Shop
- 16** Rocky Mountain Chocolate Factory
- 17** Shady Lane Marketplace
- 18** Southern Living
- 19** Space Corner
- 20** Texas Monthly News/Starbucks*
- 21** World Duty Free
- 22** XpresSpa

Electric Vehicle Charging Stations

- Blue Garage: Level 2
- Red Garage: Level 2, Near Valet Parking
- ecopark

Parking Entrance

Parking

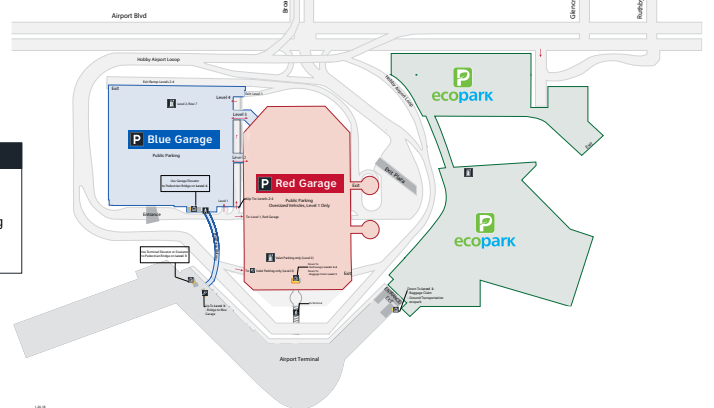

Transportation

Rental Cars:

Rental Car facilities are available at George Bush Intercontinental Airport (IAH) and William P. Hobby Airport (HOU). At IAH, the rental car lot is located 5 minutes from the airport via shuttle service. The shuttle departs every 5 minutes from outside Baggage Claim/ Arrivals in Terminals A, B, C and E between 7 a.m.– 11 p.m., and every 10 minutes between 11 p.m.–7 a.m. At HOU, rental car services are located in Curb Zone 1, outside Baggage Claim/Arrivals Level.

- Alamo: 1-888-233-8749 (IAH)
1-888-826-6893 (HOU)
- Advantage: 1-800-777-5524 (IAH)
1-713-641-9300 (HOU)
- Avis: 1-800-633-3469 (IAH)
713-641-9300 (HOU)
- Budget: 1-800-218-7992 (IAH)
1-800-218-7992 (HOU)
- Dollar Car Rental: 1-800-800-4000 (both locations)
- Enterprise: **Preferred Vendor Rate**
1-800-736-8222 (IAH)
1-800-736-8222 (HOU)
- Hertz: 1-800-654-3131 (IAH)
1-713-948-5300 (HOU)
- National: **Preferred Vendor Rate**
1-888-826-6890 (IAH)
1-888-826-6890 (HOU)
- Thrifty: 1-877-283-0898 (both locations)



Taxi Services:

Taxi Services are available at both airport locations. At IAH, taxis are located outside Baggage Claim/Arrivals Level in Terminals A, B, C and E. At HOU, taxis are located in Curb Zone 2, outside Baggage Claim/Arrivals Level.

Uber/Lyft

Ride Share services (Uber/Lyft) are available at both airports. AT IAH, Uber/Lyft is located outside Baggage Claim/Arrivals Level in Terminals A, B, C and E. At HOU, Uber/Lyft can be accessed in Curb Zone 5, outside Baggage Claim/Arrivals Level.

i Please be aware that rental car rates may change if we have negotiated rates. When requesting a rental car please insure that the EZ Tag (for all toll roads) is also included.





PTU® (Process Training Unit) at the Endress+Hauser USA Customer Center

Firearm Carry Act of 2021

Pursuant to Section 30.06, Penal Code (trespass by license holder with a concealed handgun), a person licensed under Subchapter H, Chapter 411, Government Code (handgun licensing law), may not enter this property with a concealed handgun.

Pursuant to Section 30.07, Penal Code (trespass by license holder with an openly carried handgun), a person licensed under Subchapter H, Chapter 411, Government Code (handgun licensing law), may not enter this property with a handgun that is carried openly.

De conformidad con la sección 30.06, Código penal (entrada ilegal por parte del titular de la licencia con una pistola oculta), una persona con licencia bajo el Subcapítulo H, Capítulo 411, Código de gobierno (ley de licencia de armas de fuego), no puede ingresar a esta propiedad con una pistola oculta.

De conformidad con la sección 30.07, Código penal (entrada ilegal por parte del titular de la licencia con un arma de mano abierta), una persona con licencia bajo el Subcapítulo H, Capítulo 411, Código de gobierno (ley de licencia de armas de fuego), no puede ingresar a esta propiedad con una pistola que se porta abiertamente.

Dress Code

Business casual is appropriate for all events, unless otherwise specified. Jeans are appropriate on Fridays.

PC Tour / PTU Tour Requirements:

- Open-toe shoes are not permitted
- Shoes with heels are not permitted
- Dresses or skirts should not be worn

Dining

Italiano's Restaurant This restaurant is considered one of the most popular and affordable Italian restaurants in the Houston area. Italiano's serves delicious Italian foods for lunch and dinner.

- Address: 11710 Broadway St Suite 102, Pearland, TX 77584
- Telephone: 281-812-7662
- Hours: Open for lunch/dinner daily, Sunday–Thursday, 11:00 a.m.–9:00 p.m.; Friday–Saturday, 11:00 a.m.–10:00 p.m.

Killen's Barbecue Rated in the #2 Top BBQ by Food Network and Top 50 BBQ restaurants by Texas Monthly, Killen's Barbecue is a great casual option for lunch or dinner.

- Address: 3613 E. Broadway, Pearland, TX 77581
- Telephone: 281-485-2272
- Hours: Open Tuesday–Sunday for lunch and dinner, 11:00 a.m.–Until Sold Out

Mongo This restaurant is a great local Mongolian Fire Pit and Bar. Mongo's served options including sushi, stir-fry, hibachi, and more.

- Address: 11200 Broadway St #400, Pearland, TX 77584
- Telephone: 713-340-1288
- Hours: Open daily, Sunday–Thursday, 11:00 a.m.–10:00 p.m.; Friday–Saturday, 11:00 a.m.–11:00 p.m.

Fire Stone Pizza Bar A Pearland destination for authentic wood-fired pizza, vibrant salad, flavorful soups and delicious pasta. Fire Stone Pizza Bar also offers a full bar with wine, craft beer and cocktails.

- Address: 11625 Broadway St #195, Pearland, TX 77584
- Telephone: 832-850-6677
- Hours: Open daily, Monday–Thursday, 11:00 a.m.–2:00 p.m., 4:00 p.m.–8:30 p.m.; Friday–Saturday, 11:00 a.m.–11:00 p.m.; Sunday 11:00 a.m.–8:00 p.m.

Killen's Steakhouse A local, family-owned steakhouse that serves the highest quality steak and Gulf Coast Seafood with a premier dining experience.

- Address: 6425 Broadway Street, Pearland, TX 77581
- Telephone: 281-485-0844
- Hours: Monday–Thursday 5:00–9:00 p.m., Friday–Saturday 4:00–10:00 p.m.





Gringo's Mexican Kitchen Serving residents of Texas since 1993, Gringo's Mexican Kitchen serves a variety of Tex Mex dishes and drinks.

- Address: 2202 Broadway Street, Pearland, TX 77581
- Telephone: 281-485-3844
- Hours: Sunday–Thursday 11:00 a.m.–9:00 p.m.,
Friday–Saturday 11:00 a.m.–10:00 p.m.

Fish City Grill Serving great seafood and made from scratch recipes at affordable prices, Fish City Grill offers a casual dining environment with menu options for everyone.

- Address: 11200 Broadway St #380, Pearland, TX 77584
- Telephone: 713-340-1493
- Hours: Open daily, Sunday–Thursday, 11:00 a.m.–9:30 p.m.;
Friday–Saturday, 11:00 a.m.–10:30 p.m.;
Sunday, 11:00 a.m.–9:00 p.m.

BJ's Restaurant & Brewhouse A family-friendly chain with a wide variety of pub food options and an extensive list of beers and other beverages.

- Address: 11200 Broadway Street, Ste 1700,
Pearland, TX 77584
- Telephone: 713-436-7805
- Hours: Sunday–Thursdays 11:00 a.m.–12:00 a.m.,
Friday–Saturday 11:00 a.m.–1:00 a.m.

Grazia Italian dishes, wood-fired pies and creative cocktails served in a warm, relaxed setting with a patio.

- Address: 9415 Broadway Street, St No. 103,
Pearland, TX 77584
- Telephone: 832-230-8873
- Hours: Sunday–Thursday. 11:00 a.m.–9:00 p.m.,
Friday & Saturday, 11:00 a.m.–10:00 p.m.

Cava Mediterranean restaurant for thoughtful food with customizable greens and grains bowls, pitas & salad.

- Address: 11470 Broadway ST Suite 140,
Pearland, TX 77584
- Telephone: 346-699-1428
- Hours: Monday–Sunday. 10:45 a.m.–10:00 p.m.

Local Attractions

Space Center Houston For an authentic look behind the scenes at NASA, the NASA Tram Tour travels into working areas of the Johnson Space Center.

- Address: 1601 Nasa Pkwy, Houston, TX 77058
- Telephone: 281 244-2100
- Hours: Monday–Sunday, 10:00 a.m.–5:00 p.m.

Downtown Aquarium Here, landlubbers can take a tantalizing tour of colorful, captivating undersea landscapes as varied as a sunken shipwreck and tanks full of redbellied piranhas, venomous stingrays and a shiver of sharks.

- Address: 410 Bagby St, Houston, TX 77002
- Telephone: 713 223-3474
- Hours: Sunday–Thursday, 11:00 a.m.–8:00 p.m.;
Friday–Saturday, 10:00 a.m.–11:00 p.m.;

The Houston Museum of Natural Science There’s a reason the Houston Museum of Natural Science is one of the most attended museums in the United States.

- Address: 5555 Hermann Park Dr.
- Telephone: 713 639-4629
- Hours: Monday- Sunday - 9:00 a.m. to 5:00 p.m.

Museum of Fine Arts, Houston This museum is world renowned for its nearly 60,000 works of antique and modern art gathered from nearly every corner of the world.

- Address: 1001 Bissonnet St, Houston, TX 77005
- Telephone: 713 639-7300
- Hours: Closed Monday–Tuesday;
Open Wednesday, 11:00 a.m.–5:00 p.m.
Thursday, 11:00 a.m.–9:00 p.m.
Friday–Saturday, 11:00 a.m.–6:00 p.m.
Sunday, 12:30-6:00 p.m.

Houston Zoo Featuring a collection of more than 4,500 animals, the Houston Zoo shares its efforts to preserve wildlife with the public.

- Address: 6200 Hermann Park Dr, Houston, TX 77030
- Telephone: 713 533-6500
- Hours: Monday–Sunday, 9:00 a.m.–5:00 p.m.

POST Houston Downtown Houston’s hub for culture, food, and recreation.

- Address: 401 Franklin St, Houston, TX 77201
- Telephone: 713 999-2550
- Hours: Sunday–Wednesday, 11:00 a.m.–9:00 p.m.,
Thursday–Saturday, 11:00 a.m.–10:00 p.m.

The Galleria This national icon of shopping sophistication is the top shopping destination in Houston with over 24 million visitors a year.

- Address: 5085 Westheimer Rd, Houston, TX 77056
- Telephone: 713-622-0663
- Hours: Monday-Thursday, 11:00 a.m.–7:00 p.m.
Friday–Saturday, 10:00 a.m.–8:00 p.m.
Sunday, 12:00–6:00 p.m.

Hermann Park Located in the heart of Houston, the 445-acre Hermann Park is the city’s most significant public green space, hosting more than six million visitors per year.

- Address: 6001 Fannin St, Houston, TX 77030
- Telephone: 713 524-5876
- Hours: Monday–Sunday, 6:00 a.m.–10:00 p.m.

Bowl & Barrel Stylish bowling alley featuring elevated bar fare alongside wine, craft beer and spirits.

- Address: 797 Sorella Ct Ste 118, Houston, TX 77024
- Telephone: 832 690-4480
- Hours: Sunday–Thursday, 11:00 a.m.–11:00 p.m.;
Friday–Saturday 11:00 a.m.–1:00 a.m.

Pearland Town Center A local town center with a variety of shopping and dining options.

- Address: 11200 Broadway Street, Pearland, TX 77584
- Telephone: 713-340-0712
- Hours: Monday–Saturday 10:00 a.m.–8:00 p.m.,
Sunday 12:00–6:00 p.m.

Karbach Brewing Company A local brewery with beer options for any person, regardless of what they like or where they come from. Karbach Brewing Company offers a nice atmosphere, gastropub-style food and locally brewed beer.

- Address: 2032 Karbach Street, Houston, TX 77092
- Telephone: 713-680-8886
- Hours: Monday–Saturday 11:00 a.m.–9:00 p.m.,
Sunday 11:00 a.m.–6:00 p.m.



i Hermann Park was presented to the City of Houston by George Hermann in 1914, and is now Houston's most historically significant public green space.

Topgolf Two sprawling entertainment venues with high-tech driving ranges and swanky lounges with drinks and games.

- Address: 1030 Memorial Brook Blvd, Houston, TX 77084
- Telephone: 281 406-3176
- Hours: Sunday–Thursday 10:00 a.m.–11:00 p.m.;
Friday–Saturday 10:00 a.m.–12:00 a.m.
- Address: 560 Spring Park Center Blvd., Spring, TX 77373
- Telephone: 832-200-0106
- Hours: Sunday–Thursday 10:00 a.m.–11:00 p.m.,
Friday–Saturday 10:00 a.m.–12:00 a.m.

Golf:

Pearland Golf Club

3123 Flow Field Lane, Pearland, TX 77584
713-773-9603

Clear Creek Golf Club

3902 Fellow Rd, Houston, TX 77047
713-738-8000

Memorial Park Golf Course

1001 E Memorial Loop Drive, Houston, TX 77007
832-968-7486

Wildcat Golf Club

12000 Alameda Road, Houston, TX 77045
713-413-3400

Greenwood

Endress+Hauser USA
2350 Endress Place
Greenwood, IN 46143
Tel: 317-535-7138
Sales: 888-ENDRESS
Service: 800-642-8737
Fax: 317-535-8498
info@us.endress.com
www.us.endress.com

Houston

Endress+Hauser USA Customer Center
Vector CAG Customer Center
14525 Kirby Drive
Pearland, TX 77047
Tel: 713-300-6295

Endress+Hauser USA
Vector CAG
14517 Kirby Drive
Pearland, TX 77047